



release 1.0

# /// S 219

**Compressori d'aria silenziosi rotativi a vite**

*Silent rotary screw air compressor*

Tecnologia italiana dal 1977 per una scelta che dura nel tempo  
*Italian technology since 1977 for a choice that lasts overtime*

**fiac**  
AIR COMPRESSORS

# FIAC Bologna (Italy)

## Headquarter



Tecnologia italiana dal 1977 per una scelta che dura nel tempo  
*Italian technology since 1977 for a choice that lasts overtime*



**FIAC S.p.A.** attiva dal 1977 sul mercato internazionale, è caratterizzata da una evoluzione dinamica della quale il cliente, con le sue esigenze ed aspettative, è il motore propulsivo.

È attraverso la soddisfazione degli utilizzatori che FIAC intende aumentare e rinnovare i prodotti, al tempo stesso mantenendo le sue caratteristiche di creatività, flessibilità e adattamento alle esigenze del mercato.

Il tipo di organizzazione adottata da FIAC, per garantire la continuità della qualità dei suoi prodotti e la gestione generale, permette all'azienda di verificare e misurare le proprie performance atte al miglioramento continuo.

Tutti i livelli dell'organizzazione sono coinvolti e gli obiettivi e i risultati così ottenuti sono condivisi da tutta l'azienda, nota da sempre nel mondo dell'aria compressa per l'alta qualità dei suoi prodotti e per il suo servizio clienti.

Il sistema di gestione della qualità, certificato UNI EN ISO 9001:2008, completa perfettamente la politica di controllo che FIAC ha adottato sulla base di continui miglioramenti mirati alla totale soddisfazione del cliente finale.

*FIAC S.p.A. actives since 1977 on the international market, characterised by a dynamic evolution in which the customer, with his requirements and expectations, is the centre of attention.*

*It is through the customer's satisfaction that FIAC intends to increase and renew its products, at the same time as maintaining its characteristics of creativity, flexibility and adjustment to the market requirements.*

*The type of organisation adopted by FIAC, to ensure the continuity of the quality of its products and its overall organisation, answers to patterns which require the company to check and measure its own performance for continual improvement. All levels of the organisation are involved and the aims and results thus obtained are shared throughout. FIAC S.p.A. has always been renowned in the world of compressed air for the high quality of its products and for its customer service.*

*The UNI EN ISO 9001:2008 norms perfectly complement the policy of quality control that FIAC has adopted, based on continuous improvements aimed at the complete satisfaction of the final customer.*

# La nostra tecnologia

## Our technology



### Unità di compressione

Il gruppo vite è caratterizzato da alta efficienza a bassa velocità di rotazione grazie al giusto dimensionamento dei rotori, allo studio dei profili ed alla scelta ottimale del numero dei lobi con conseguente riduzione della rumorosità. L'affidabilità del gruppo è assicurata dal sovradimensionamento dei cuscinetti portanti e di spinta, da un anello paraolio a doppio labbro con perfetta tenuta sull'albero del rotore conduttore e dal raffreddamento ad iniezione d'olio.

### Air End

The screw element combines optimal running speeds with high efficiency thanks to the appropriate sizing of the rotors, to the design of the profiles and to the perfect choice of the number of lobes with consequent reduction in noise level. The unit's reliability is guaranteed by the oversized loadcarrying and thrust bearings, by an oil seal ring with double lip that seals the shaft of the driving rotor perfectly and by the oil-injection cooling system.



### La giusta soluzione per ogni esigenza

I nostri clienti sono piccoli artigiani e grandi industrie, grandi differenze di necessità, consumi di aria compressa irregolari e continui. Dall'esperienza di oltre 35 anni e il rapporto diretto con i nostri clienti, nasce una vasta gamma di compressori a vite progettati per adattarsi al meglio nelle diverse situazioni di utilizzo, d'installazione e condizioni ambientali, con particolare attenzione alla lubrificazione e temperatura di funzionamento.

### The right solution for each application

Our customers are small producers and big industry, very different needs, irregular and continuous consumption of compressed air. From our experience for over 35 years and a direct communication with our customers, born the huge range of screw compressors, projected to fit better in different situations of use, installation and environmental conditions, by a correct lubrication and temperature.



### Semplice e di facile manutenzione

Nella realizzazione delle serie NEW SILVER e AIRBLOK è stata severamente testata l'affidabilità dei componenti utilizzati, razionalizzandone la disposizione per una facile accessibilità, con l'obiettivo di garantire costi di manutenzione e tempi di intervento ridotti. Per un'assistenza rapida ed efficiente FIAC ha sviluppato, insieme al proprio staff tecnico qualificato, dei kit di manutenzione programmata unitamente ad un dettagliato manuale di servizio.

### Simple and easy maintenance

The reliability of the components utilized has been exhaustively tested in the production of the NEW SILVER and AIRBLOK series. Their arrangement has been rationalised to ensure easy access in the aim of making maintenance much quicker and cheaper. In collaboration with its highly qualified technical staff, FIAC has developed a scheduled maintenance kit, which comes complete with a detailed service manual in order to make maintenance jobs much quicker and more efficient.



### Ricambi originali

Tutti i componenti utilizzati nei compressori a vite FIAC sono stati progettati, realizzati e selezionati per fornire ai nostri clienti macchine affidabili che durino nel tempo. Solo l'utilizzo di parti originali, che hanno superato i più severi test qualitativi e prestazionali, possono garantire elevata efficienza, lunga durata del prodotto riducendo i costi di esercizio del vostro impianto di aria compressa. Verificate sempre che la manutenzione del compressore sia effettuata da personale qualificato ed autorizzato e che i ricambi siano marcati Original Part.

### Original Spare Parts

Whole components of FIAC screw compressors are designed, produced and selected to supply to our customers machines that lasts over time. Only genuine spare part, who have passed the most severe tests of quality and performance, can provide the best compressor performance, long life time and minimum cost of your compressed air plant use. Check always that your compressor maintenance must be done by professional and authorized technician and the spare parts are signed Original Part.

# NEW SILVER 3 ÷ 100

## Compressori d'aria silenziosi rotativi a vite integrati

*Silent encapsulated rotary screw compressors*

HIGH EFFICIENCY  
MOTOR IE3



FIAC ha ampliato la gamma dei compressori a vite silenziosi New Silver atta a soddisfare le richieste di generatori d'aria compressa da 3 a 100 HP, compressori semplici, economici ma tecnologicamente evoluti.

*Fiac has expanded the range of the low noise screw compressors New Silver to satisfy the demands for generators of compressed air from 3 to 100 HP, compressors simple economical but technologically advanced.*



### Easy Control 2

Il FIAC EASY CONTROL gestisce, monitorizza e ottimizza le fasi di funzionamento dell'unità. La riduzione dei consumi energetici è ottenuta grazie a un'efficace ed affidabile regolazione marcia/arresto. Facile e immediata lettura dei dati quali: pressione di rete, temperatura di fine compressione, conta ore per il tempo di marcia a carico e a vuoto, allarmi di protezione e segnalazioni per la manutenzione.

### Easy Control 2

*FIAC EASY CONTROL manages, monitors and optimises the duty cycle of the unit, the reduction of the power consumption is obtained thanks to an effective and reliable adjustable start/stop. Easy and immediate reading of the data: air pressure, oil temperature, hour meter for compression and idle running time, protection alarms and maintenance schedules.*



### Controllo sistema di essiccazione

Visualizzazione immediata del punto di rugiada. Regolazione degli intervalli e tempi di scarico condensa. Funzione automatica per risparmio energetico.

### Air dryer system control

*Continuous visualization of dew point.  
Setting of interval and time of condensation discharge.  
Automatic function for energy saving.*



### Scarico condensa

Il rubinetto a sfera di facile accessibilità fissato al piede del serbatoio permette di scaricare la condensa manualmente.

### Condensate drainage

*The drain tap is easily affixed to the foot of the tank.*



### Struttura e insonorizzazione

Telaio realizzato in lamiera verniciata e rinforzata con nervature. Pannelli fono assorbenti lavabili ad alta densità a cellule chiuse.

### Structure and noise reduction

*Chassis totally realized in painted metal parts. Sound proof washable panels made by high density of cells.*



### Componenti elettrici

Motori ad alta efficienza IE3. IP54 Classe isolamento F.

### Electric components

*IE3 high efficiency motor.  
IP 54 Insulation Class F.*



# NEW SILVER

## Compressori d'aria silenziosi rotativi a vite integrati

*Silent encapsulated rotary screw compressors*



NEW SILVER è la soluzione ideale per tutti gli utilizzatori che necessitano di una stazione completa, di facile utilizzo, idonea a un funzionamento continuo e costante nel tempo.

*NEW SILVER is the ideal solution for customers who need a complete air station which is easy to use, suitable for continuous and constant operation over time.*



### Gruppo vite COMPACT F01

La soluzione integrata del nuovo gruppo vite garantisce le migliori prestazioni della categoria, alta efficienza ed affidabilità. Unità di compressione monostadio raffreddata ad iniezione di fluido, studiata appositamente per ottenere ampia accessibilità in fase di manutenzione e con pochi componenti soggetti ad usura.

#### *Encapsulated Air end F01*

*The encapsulated solution of the new air end guarantees the best performances of the category, high efficiency and reliability. Single stage air end, injection oil cooled to fluid, studied purposely in order to obtain good accessibility during maintenance and with few parts subject to wear and tear.*



### Sistema di ventilazione

Le nuove unità NEW SILVER sono dotate di un'efficace sistema di raffreddamento dell'aria. Un'elettroventola assiale indipendente ed il controllo termico asservito alla scheda elettronica FIAC EASY CONTROL, permettono un lavoro costante della macchina anche in condizioni termiche non ottimali.

#### *Cooling system*

*The NEW SILVER are equipped with an independent axial electric fan thermally controlled by electronic dashboard FIAC EASY CONTROL. Constant air/oil temperatures grant durability of the components even during heavy duty working conditions.*

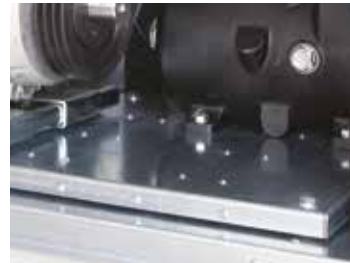

### Piattaforma antivibrante

La base di fissaggio del gruppo vite e motore elettrico è fissata su supporti antivibranti. Questa soluzione permette di eliminare la trasmissione delle vibrazioni alla struttura portante del compressore, con una notevole diminuzione del rumore e dello stress meccanico su tutte le parti fissate alla struttura stessa.

#### *Anti-vibration base*

*The assembly base of the air end and electric motor is fixed on anti-vibrations supports. This solution allows to eliminate the transmission of vibrations to the main structure of the compressor, with a considerable reduction of noise and mechanical stress on all parts fixed into the structure.*



### Trasmissione

La trasmissione mediante cinghia a nervature longitudinali e le pulegge in ghisa garantiscono una lunga durata ed un elevato rendimento nel tempo.

#### *Transmission*

*Transmission by belt longitudinal ribbings guarantees long durability and elevated power transmission in the time. Pulleys are made of cast iron.*



### Slitta

Sistema regolabile di tensionamento delle cinghie con piastra scorrevole su guide. Rapida e sicura sostituzione delle cinghie.

#### *Sliding plate*

*Adjustable belt tensioning system by sliding plate along guides. Quick and safe belt maintenance.*

# NEW SILVER 3

Trasmissione diretta / *Direct drive*

## Compressori d'aria rotativi a vite

*Rotary screw compressors*



///  
NEW SILVER  
3/300 DR

///  
NEW SILVER  
3/90 DR

///  
NEW SILVER V  
3/300 DR

///  
NEW SILVER  
3/34 DR



# NEW SILVER 3/34 - 3/90 - 3/300 - V 3/300

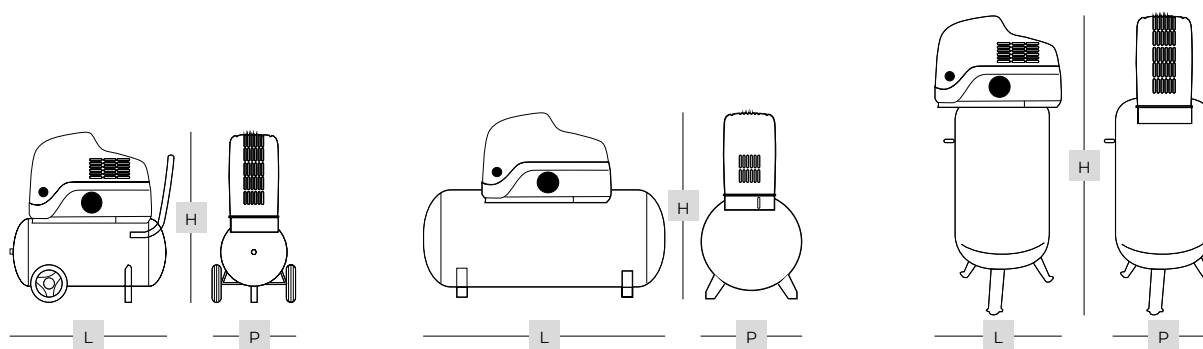
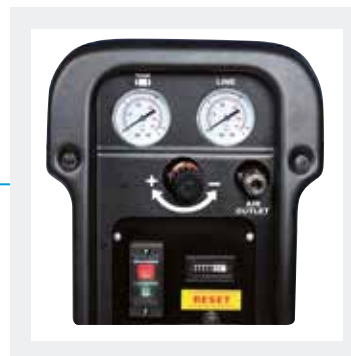

Type	Code						LxPxH					
	EAN CODE	I	dB (A)	l/min	CFM	m <sup>3</sup> /h	bar	psi	HP	kW	mm in	kg lb
NEW SILVER 3/34 DR	1121680885	on request	34	59	300	10.6	18	9	130	3	750x585x790 29.6x23x31	52 116
NEW SILVER 3/90 DR	1121680814	on request	90	59	300	10.6	18	9	130	3	1000x400x1114 39.4x16x43.9	84 185
NEW SILVER 3/300 DR	1121720620	on request	270	59	300	10.6	18	9	130	3	1600x560x1230 63x22x48.4	135 297
NEW SILVER V 3/300 DR	1121720218	8020119149362	270	59	300	10.6	18	9	130	3	670x670x1850 26.4x26x72.8	145 319

Avviamento diretto / DOL start up  
 Alimentazione standard 230V/50Hz/1 / Standard input 230V/50Hz/1  
 Disponibili versioni / Version available: 400V/50Hz/3 - 220V/60Hz/1 - 380V/60Hz/3

# NEW SILVER 3 ÷ 10

Trasmissione a cinghia / *Belt drive*

**Compressori d'aria silenziosi rotativi a vite integrati con o senza essiccatore**

*Silent encapsulated rotary screw compressors with or without dryer*

HIGH EFFICIENCY  
**MOTOR IE3**  
da 10 HP / from 10 HP



Modulo: solo compressore  
*Module: only compressor*

Type	Code							LxPxH					
		EAN CODE	dB (A)	l/min	CFM	m <sup>3</sup> /h	bar	psi	BSP	HP	kW	mm in	kg lb
NEW SILVER 3	1121730288	on request		320	11.3	19,2	8	116					
	1121730091	on request	63	280	9.9	16,8	10	145	1/2"	3	2,2	846x572x750 33.3x22.5x29.5	134 298
	1121730289	on request		240	8.5	14,4	13	189					
NEW SILVER 4	1121730290	on request		490	17.3	29,4	8	116					
	1121730092	on request	64	415	14.7	24,9	10	145	1/2"	4	3	846x572x750 33.3x22.5x29.5	136 302
	1121730291	on request		350	12.4	21	13	189					
NEW SILVER 5,5*	1121690100	on request		560	19.8	33,6	8	116					
	1121690101	on request	65	450	15.9	27	10	145	1/2"	5,5	4	846x572x750 33.3x22.5x29.5	138 307
	1121690102	on request		400	14.1	24	13	188					
NEW SILVER 7,5	1121690103	on request		820	29	49,2	8	116					
	1121690104	on request	66	720	25.4	43,2	10	145	1/2"	7,5	5,5	846x572x750 33.3x22.5x29.5	143 318
	1121690105	on request		640	22.6	38,4	13	188					
NEW SILVER 10	1121690106	on request		950	33.5	57	8	116					
	1121690107	8020119110966	67	860	30.4	51,6	10	145	1/2"	10	7,5	846x572x750 33.3x22.5x29.5	148 329
	1121690108	on request		690	24.4	41,4	13	188					

Avviamento diretto / *DOL start up*

Alimentazione standard 400V/50Hz/3 / *Standard input 400V/50Hz/3*

Disponibili versioni / *Version available: 230V/50Hz/3 - 220V/60Hz/3 - 380V/60Hz/3 - 460V/60Hz/3*

# NEW SILVER D 3 ÷ 10

Trasmissione a cinghia / *Belt drive*

**Compressori d'aria silenziosi rotativi a vite integrati con o senza essiccatore**

*Silent encapsulated rotary screw compressors with or without dryer*

HIGH EFFICIENCY  
**MOTOR IE3**  
da 10 HP / from 10 HP

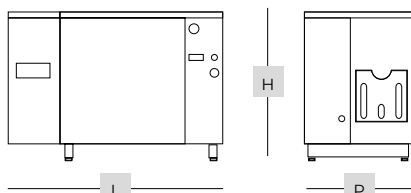

Modulo: compressore + essiccatore  
*Module: compressor + dryer*

Type	Code									LxPxH			
	EAN CODE		dB (A)	l/min	CFM	m <sup>3</sup> /h	bar	psi	BSP	HP	kW	mm in	kg lb
NEW SILVER D 3	1121730304	on request		320	11.3	19,2	8	116					
	1121730305	on request	63	280	9.9	16,8	10	145	1/2"	3	2,2	1105x616x750 43.5x24.3x29.5	164 365
	1121730306	on request		240	8.5	14,4	13	189					
NEW SILVER D 4	1121730307	on request		490	17.3	29,4	8	116					
	1121730308	on request	64	415	14.7	24,9	10	145	1/2"	4	3	1105x616x750 43.5x24.3x29.5	166 369
	1121730309	on request		350	12.4	21	13	189					
NEW SILVER D 5,5*	1121720460	on request		560	19.8	33,6	8	116					
	1121720461	on request	65	450	15.9	27	10	145	1/2"	5,5	4	1105x540x750 43.5x21x29.5	168 374
	1121720462	on request		400	14.1	24	13	188					
NEW SILVER D 7,5	1121720463	on request		820	29	49,2	8	116					
	1121720464	on request	66	720	25.4	43,2	10	145	1/2"	7,5	5,5	1105x540x750 43.5x21x29.5	173 384
	1121720465	on request		640	22.6	38,4	13	188					
NEW SILVER D 10	1121720466	on request		950	33.5	57	8	116					
	1121720467	on request	67	860	30.4	51,6	10	145	1/2"	10	7,5	1105x540x750 43.5x21x29.5	178 396
	1121720468	on request		690	24.4	41,4	13	188					

D = con essiccatore / *with dryer*

\* Avviamento diretto / *DOL start up*

Alimentazione standard 400V/50Hz/3 / *Standard input 400V/50Hz/3*

Disponibili versioni / *Version available: 230V/50Hz/3 - 220V/60Hz/3 - 380V/60Hz/3 - 460V/60Hz/3*

# NEW SILVER 10S ÷ 20

Trasmissione a cinghia / *Belt drive*

**Compressori d'aria silenziosi rotativi a vite integrati con o senza essiccatore**

*Silent encapsulated rotary screw compressors with or without dryer*

HIGH EFFICIENCY  
MOTOR IE3

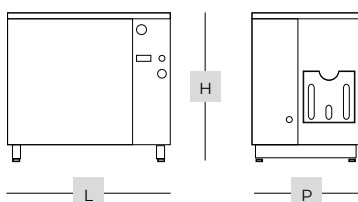

Modulo: solo compressore  
*Module: only compressor*

Type	Code								LxPxH				
	EAN CODE		dB (A)	l/min	CFM	m <sup>3</sup> /h	bar	psi	BSP	HP	kW	mm in	kg lb
NEW SILVER 10S	1121730271	on request		1180	41.6	70,8	8	116					
	1121720876	on request	64	1000	35.3	60	10	145	3/4"	10	7,5	994x672x827	245
	1121730272	on request		800	28.2	48	13	188				39.1x26.5x32.6	540
NEW SILVER 15	1121680282	on request		1560	55.1	93,6	8	116					
	1121680283	on request	65	1430	50.5	85,8	10	145	3/4"	15	11	994x672x827	254
	1121680284	on request		1210	42.7	72,6	13	188				39.1x26.5x32.6	564
NEW SILVER 20	1121680285	on request		2010	71	120,6	8	116					
	1121680286	8020119125274	67	1900	67.1	114	10	145	3/4"	20	15	994x672x827	280
	1121680287	on request		1670	59	100,2	13	188				39.1x26.5x32.6	622

Alimentazione standard 400V/50Hz/3 / *Standard input 400V/50Hz/3*

Disponibili versioni / *Version available: 230V/50Hz/3 - 220V/60Hz/3 - 380V/60Hz/3 - 460V/60Hz/3*

# NEW SILVER D 10S ÷ 20

Trasmissione a cinghia / *Belt drive*

**Compressori d'aria silenziosi rotativi a vite integrati con o senza essiccatore**

*Silent encapsulated rotary screw compressors with or without dryer*

HIGH EFFICIENCY  
MOTOR IE3

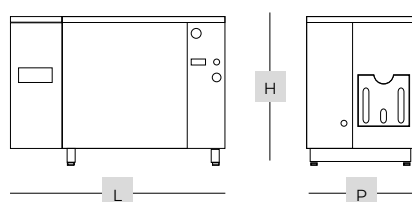

Modulo: compressore + essiccatore  
*Module: compressor + dryer*

Type	Code							LxPxH					
	EAN CODE	dB (A)	l/min	CFM	m <sup>3</sup> /h	bar	psi	BSP	HP	kW	mm in	kg lb	
NEW SILVER D 10S	1121730273	on request		1180	41.6	70,8	8	116					
	1121720915	on request	64	1000	35.3	60	10	145	1/2"	10	7,5	1252x672x827 49.3x26.5x32.6	245 540
	1121730275	on request		800	28.2	48	13	188					
NEW SILVER D 15	1121720469	on request		1560	55.1	93,6	8	116					
	1121720470	on request	65	1430	50.5	85,8	10	145	3/4"	15	11	1252x672x827 49.3x26.5x32.6	290 644
	1121720471	on request		1210	42.7	72,6	13	188					
NEW SILVER D 20	1121720472	on request		2010	71	120,6	8	116					
	1121720473	on request	67	1900	67.1	114	10	145	3/4"	20	15	1252x672x827 49.3x26.5x32.6	316 702
	1121720474	on request		1670	59	100,2	13	188					

D = con essiccatore / *with dryer*

Alimentazione standard 400V/50Hz/3 / *Standard input 400V/50Hz/3*

Disponibili versioni / *Version available: 230V/50Hz/3 - 220V/60Hz/3 - 380V/60Hz/3 - 460V/60Hz/3*

# NEW SILVER 3 ÷ 20

Trasmissione a cinghia / *Belt drive*

## Compressori d'aria silenziosi rotativi a vite integrati con serbatoio

*Silent encapsulated rotary screw compressors tank mounted*

HIGH EFFICIENCY  
MOTOR IE3

da 10 HP / from 10 HP

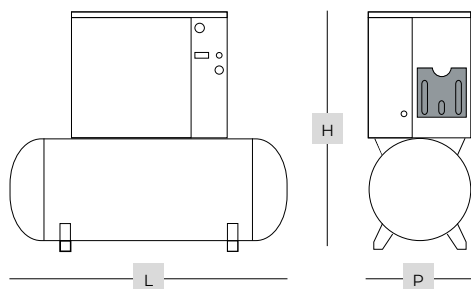

Modulo: compressore + serbatoio  
*Module: compressor + tank*

Type	Code	EAN CODE	I	dB (A)	l/min	CFM	m³/h	bar	psi	BSP	HP	kW	LxPxH		
													mm	in	kg
NEW SILVER 3/200	1121730310	on request			320	11.3	19,2	8	116						
	1121730311	on request	200	63	280	9.9	16,8	10	145	1/2"	3	2,2	1532x572x1225	191	
	1121730312	on request			240	8.5	14,4	13	189				60.3x22.5x48.2	425	
NEW SILVER 3/300	1121730313	on request			320	11.3	19,2	8	116						
	1121730314	8020119147610	270	63	280	9.9	16,8	10	145	1/2"	3	2,2	1631x572x1274	201	
	1121730315	on request			240	8.5	14,4	13	189				64.2x22.5x50.2	447	
NEW SILVER 4/200	1121730316	on request			490	17.3	29,4	8	116						
	1121730317	on request	200	64	415	14.7	24,9	10	145	1/2"	4	3	1532x572x1225	193	
	1121730318	on request			350	12.4	21	13	189				60.3x22.5x48.2	429	
NEW SILVER 4/300	1121730319	on request			490	17.3	29,4	8	116						
	1121730320	on request	270	64	415	14.7	24,9	10	145	1/2"	3	2,2	1631x572x1274	203	
	1121730321	on request			350	12.4	21	13	189				64.2x22.5x48.2	451	
NEW SILVER 5,5/200*	1121690109	on request			560	19.8	33,6	8	116						
	1121690110	on request	200	65	450	15.9	27	10	145	1/2"	5,5	4	1532x572x1225	195	
	1121690111	on request			400	14.1	24	13	188				60.3x22.5x48.2	433	
NEW SILVER 5,5/300*	1121690118	on request			560	19.8	33,6	8	116						
	1121690119	on request	270	65	450	15.9	27	10	145	1/2"	5,5	4	1631x572x1274	205	
	1121690120	on request			400	14.1	24	13	188				64.2x22.5x48.2	455	
NEW SILVER 7,5/300	1121690121	on request			820	29	49,2	8	116						
	1121690122	on request	270	66	720	25.4	43,2	10	145	1/2"	7,5	5,5	1631x572x1274	212	
	1121690123	on request			640	22.6	38,4	13	188				64.2x22.5x48.2	471	
NEW SILVER 7,5/500	1121690130	on request			820	29	49,2	8	116						
	1121690131	on request	500	66	720	25.4	43,2	10	145	3/4"	7,5	5,5	2038x600x1367	255	
	1121690132	on request			640	22.6	38,4	13	188				80.2x23.6x53.8	567	
NEW SILVER 10/300	1121690124	on request			950	33.5	57	8	116						
	1121690125	on request	270	67	860	30.4	51,6	10	145	1/2"	10	7,5	1631x572x1274	217	
	1121690126	on request			690	24.4	41,4	13	188				64.2x22.5x48.2	482	
NEW SILVER 10/500	1121690133	on request			950	33.5	57	8	116						
	1121690134	8020119141014	500	67	860	30.4	51,6	10	145	3/4"	10	7,5	2038x600x1367	260	
	1121690135	on request			690	24.4	41,4	13	188				80.2x23.6x53.8	578	
NEW SILVER 10S/300	1121730276	on request			1180	41.6	70,8	8	116						
	1121730277	on request	300	64	1000	35.3	60	10	145	3/4"	10	7,5	1631x700x1353	280	
	1121730278	on request			800	28.2	48	13	188				64.2x27.6x53.3	623	
NEW SILVER 10S/500	1121730279	on request			1180	41.6	70,8	8	116						
	1121730280	on request	500	64	1000	35.3	60	10	145	1/2"	10	7,5	2038x700x1446	304	
	1121730281	on request			800	28.2	48	13	188				80.2x27.6x56.9	676	
NEW SILVER 15/300	1121680288	on request			1560	55.1	93,6	8	116						
	1121680289	on request	270	65	1430	50.5	85,8	10	145	1/2"	15	11	1631x700x1353	325	
	1121680290	on request			1210	42.7	72,6	13	188				64.2x27.6x53.3	722	
NEW SILVER 15/500	1121680294	on request			1560	55.1	93,6	8	116						
	1121680295	on request	500	65	1430	50.5	85,8	10	145	3/4"	15	11	2038x700x1446	349	
	1121680296	on request			1210	42.7	72,6	13	188				80.2x27.6x56.9	775	
NEW SILVER 20/300	1121680291	on request			2010	71	120,6	8	116						
	1121680292	on request	270	67	1900	67.1	114	10	145	1/2"	20	15	1631x700x1353	351	
	1121680293	on request			1670	59	100,2	13	188				64.2x27.6x53.3	780	
NEW SILVER 20/500	1121680297	on request			2010	71	120,6	8	116						
	1121680298	on request	500	67	1900	67.1	114	10	145	3/4"	20	15	2038x700x1446	392	
	1121680299	on request			1670	59	100,2	13	188				80.2x27.6x56.9	871	

\* Avviamento diretto / DOL start up  
 Alimentazione standard 400V/50Hz/3 / Standard input 400V/50Hz/3  
 Disponibili versioni / Version available: 230V/50Hz/3 - 220V/60Hz/3 - 380V/60Hz/3 - 460V/60Hz/3

# NEW SILVER D 3/200 ÷ 20/500

Trasmissione a cinghia / *Belt drive*

**Compressori d'aria silenziosi rotativi a vite integrati con serbatoio ed essiccatore**

*Silent encapsulated rotary screw compressors tank mounted with dryer*





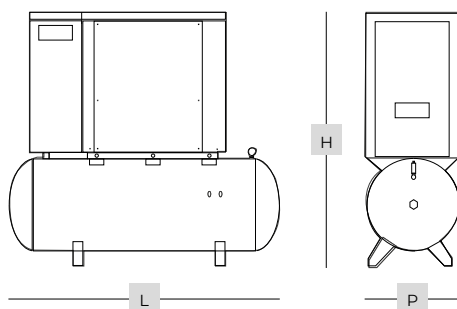



La stazione d'aria completa  
*Full features air station*

HIGH EFFICIENCY  
**MOTOR IE3**  
da 10 HP / from 10 HP



Modulo: compressore + serbatoio + essiccatore  
*Module: compressor + tank + dryer*



Type	Code								LxPxH						
	EAN CODE	I	dB (A)	l/min	CFM	m <sup>3</sup> /h	bar	psi	BSP	HP	kW	mm in	kg lb		
NEW SILVER D 3/200	1121730322	on request		320	11.3	19,2	8	116							
	1121730323	on request	200	63	280	9.9	16,8	10	145	1/2"	3	2,2	1532x572x1225 60.3x22.5x48.2	231 514	
	1121730324	on request			240	8.5	14,4	13	189						
NEW SILVER D 3/300	1121730325	on request		320	11.3	19,2	8	116							
	1121730326	on request	270	63	280	9.9	16,8	10	145	1/2"	3	2,2	1631x572x1274 64.2x22.5x50.2	241 536	
	1121730327	on request			240	8.5	14,4	13	189						
NEW SILVER D 4/200	1121730328	on request		490	17.3	29,4	8	116							
	1121730329	on request	200	64	415	14.7	24,9	10	145	1/2"	4	3	1532x572x1225 60.3x22.5x48.2	233 518	
	1121730330	on request			350	12.4	21	13	189						
NEW SILVER D 4/300	1121730331	on request		490	17.3	29,4	8	116							
	1121730332	on request	270	64	415	14.7	24,9	10	145	1/2"	3	2,2	1631x572x1274 64.2x22.5x50.2	243 540	
	1121730333	on request			350	12.4	21	13	189						
NEW SILVER D 5,5/200*	1121690136	on request		560	19.8	33,6	8	116							
	1121690137	on request	200	65	450	15.9	27	10	145	1/2"	5,5	4	1532x572x1225 60.3x22.5x48.2	235 522	
	1121690138	on request			400	14.1	24	13	188						
NEW SILVER D 5,5/300*	1121690140	on request		560	19.8	33,6	8	116							
	1121690146	on request	270	65	450	15.9	27	10	145	1/2"	5,5	4	1631x572x1274 64.2x22.5x50.2	245 544	
	1121690147	on request			400	14.1	24	13	188						
NEW SILVER D 7,5/300	1121690148	on request		820	29	49,2	8	116							
	1121690149	on request	270	66	720	25.4	43,2	10	145	1/2"	7,5	5,5	1631x572x1274 64.2x22.5x50.2	252 560	
	1121690150	on request			640	22.6	38,4	13	188						
NEW SILVER D 7,5/500	1121690157	on request		820	29	49,2	8	116							
	1121690158	on request	500	66	720	25.4	43,2	10	145	3/4"	7,5	5,5	2038x600x1367 80.2x23.6x53.8	295 655	
	1121690159	on request			640	22.6	38,4	13	188						
NEW SILVER D 10/300	1121690151	on request		950	33.5	57	8	116							
	1121690152	on request	8020119068854	270	67	860	30.4	51,6	10	145	1/2"	10	7,5	1631x572x1274 64.2x22.5x50.2	257 571
	1121690153	on request			690	24.4	41,4	13	188						
NEW SILVER D 10/500	1121690160	on request		950	33.5	57	8	116							
	1121690161	on request	500	67	860	30.4	51,6	10	145	1/2"	10	7,5	2038x600x1367 80.2x23.6x53.8	300 667	
	1121690162	on request			690	24.4	41,4	13	188						
NEW SILVER D 10S/300	1121730282	on request		1180	41.6	70,8	8	116							
	1121730283	on request	300	64	1000	35.3	60	10	145	3/4"	10	7,5	1631x700x1353 64.2x27.6x53.3	365 811	
	1121730284	on request			800	28.2	48	13	188						
NEW SILVER D 10S/500	1121730285	on request		1180	41.6	70,8	8	116							
	1121730286	on request	500	64	1000	35.3	60	10	145	3/4"	10	7,5	2038x630x1430 80.2x27.6x56.9	390 866	
	1121730287	on request			800	28.2	48	13	188						
NEW SILVER D 15/300	1121680300	on request		1560	55.1	93,6	8	116							
	1121680301	on request	8020119099957	270	65	1430	50.5	85,8	10	145	3/4"	15	11	1631x700x1353 64.2x27.6x53.3	365 811
	1121680302	on request			1210	42.7	72,6	13	188						
NEW SILVER D 15/500	1121680306	on request		1560	55.1	93,6	8	116							
	1121680307	on request	500	65	1430	50.5	85,8	10	145	3/4"	15	11	2038x700x1446 80.2x27.6x56.9	390 866	
	1121680308	on request			1210	42.7	72,6	13	188						
NEW SILVER D 20/300	1121680303	on request		2010	71	120,6	8	116							
	1121680304	on request	270	67	1900	67.1	114	10	145	3/4"	20	15	1631x700x1353 64.2x27.6x53.3	392 871	
	1121680305	on request			1670	59	100,2	13	188						
NEW SILVER D 20/500	1121680309	on request		2010	71	120,6	8	116							
	1121680310	on request	500	67	1900	67.1	114	10	145	3/4"	20	15	2038x700x1446 80.2x27.6x56.9	438 973	
	1121680311	on request			1670	59	100,2	13	188						

D = con essiccatore / with dryer

\* Avviamento diretto / DOL start up

Alimentazione standard 400V/50Hz/3 / Standard input 400V/50Hz/3

Disponibili versioni / Version available: 230V/50Hz/3 - 220V/60Hz/3 - 380V/60Hz/3 - 460V/60Hz/3

# NEW SILVER 25 ÷ 30

Trasmissione a cinghia / *Belt drive*

**Compressori d'aria silenziosi rotativi a vite integrati con o senza essiccatore**

*Silent encapsulated rotary screw compressors with or without dryer*

HIGH EFFICIENCY  
MOTOR IE3

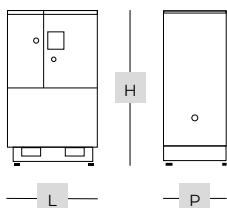

Modulo: solo compressore  
*Module: only compressor*

Type	Code							LxPxH					
	EAN CODE		dB (A)	l/min	CFM	m <sup>3</sup> /h	bar	psi	BSP	HP	kW	mm in	kg lb
NEW SILVER 25	1121720412	on request		2700	95.3	162	8	116					
	1121720413	on request	73	2500	88.3	150	10	145	1"	25	18.5	1005x884x1180 39.6x34.8x46.5	468 1044
	1121720414	on request		2200	77.7	132	13	188					
NEW SILVER 30	1121720415	on request		3280	115.8	196,8	8	116					
	1121720037	on request	74	2970	104.9	178,2	10	145	1"	30	22	1005x884x1180 39.6x34.8x46.5	498 1111
	1121720416	on request		2390	84.4	143,4	13	188					

Alimentazione standard 400V/50Hz/3 / *Standard input 400V/50Hz/3*  
Disponibili versioni / *Version available: 230V/50Hz/3 - 220V/60Hz/3 - 380V/60Hz/3 - 460V/60Hz/3*

# NEW SILVER D 25 ÷ 30

Trasmissione a cinghia / *Belt drive*

**Compressori d'aria silenziosi rotativi a vite integrati con o senza essiccatore**

*Silent encapsulated rotary screw compressors with or without dryer*

HIGH EFFICIENCY  
MOTOR IE3

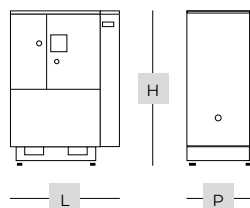

Modulo: compressore + essiccatore  
*Module: compressor + dryer*

Type	Code	EAN CODE	dB (A)	CFM		m <sup>3</sup> /h	bar	psi	BSP	HP	kW	LxPxH mm in	kg lb
				l/min	CFM								
NEW SILVER D 25	1121720435	on request		2700	95.3	162	8	116					
	1121720436	on request	73	2500	88.3	150	10	145	1"	25	18.5	1170x884x1180 46.1x34.8x46.5	488 1088
	1121720437	on request		2200	77.7	132	13	188					
NEW SILVER D 30	1121720438	on request		3280	115.8	196,8	8	116					
	1121720439	on request	74	2970	104.9	178,2	10	145	1"	30	22	1170x884x1180 46.1x34.8x46.5	518 1155
	1121720440	on request		2390	84.4	143,4	13	188					

D = con essiccatore / *with dryer*

Alimentazione standard 400V/50Hz/3 / *Standard input 400V/50Hz/3*

Disponibili versioni / *Version available: 230V/50Hz/3 - 220V/60Hz/3 - 380V/60Hz/3 - 460V/60Hz/3*

# NEW SILVER 25/500 ÷ 30/500

Trasmissione a cinghia / *Belt drive*

## Compressori d'aria rotativi a vite integrati su serbatoio con o senza essiccatore

*Silent encapsulated rotary screw compressors tank mounted with or without dryer*

HIGH EFFICIENCY  
MOTOR IE3



Modulo: compressore + serbatoio  
*Module: compressor + tank*

Type	Code									LxPxH				
	EAN CODE	I	dB (A)	l/min	CFM	m <sup>3</sup> /h	bar	psi	BSP	HP	kW	mm in	kg lb	
NEW SILVER 25/500	1121720441	on request			2700	95.3	162	8	116					
	1121720442	on request	500	73	2500	88.3	150	10	145	1"	25	18.5	2038x884x1790 80.2x34.8x70.5	670 1494
	1121720443	on request			2200	77.7	132	13	188					
NEW SILVER 30/500	1121720444	on request			3280	115.8	196,8	8	116					
	1121720445	on request	500	74	2970	104.9	178,2	10	145	1"	30	22	2038x884x1790 80.2x34.8x70.5	700 1561
	1121720446	on request			2390	84.4	143,4	13	188					

Alimentazione standard 400V/50Hz/3 / *Standard input 400V/50Hz/3*  
Disponibili versioni / *Version available: 230V/50Hz/3 - 220V/60Hz/3 - 380V/60Hz/3 - 460V/60Hz/3*

# NEW SILVER D 25/500 ÷ 30/500

Trasmissione a cinghia / *Belt drive*

**Compressori d'aria rotativi a vite integrati su serbatoio con o senza essiccatore**

*Silent encapsulated rotary screw compressors tank mounted with or without dryer*

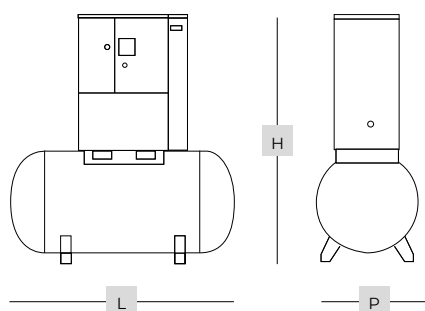

Modulo: compressore + serbatoio + essiccatore  
 Module: compressor + tank + dryer

Type	Code								LxPxH					
	EAN CODE	I	dB (A)	l/min	CFM	m <sup>3</sup> /h	bar	psi	BSP	HP	kW	mm in	kg lb	
NEW SILVER D 25/500	1121720447	on request		2700	95.3	162	8	116						
	1121720448	on request	500	73	2500	88.3	150	10	145	1"	25	18.5	2038x884x1790 80.2x34.8x70.5	670 1494
	1121720449	on request			2200	77.7	132	13	188					
NEW SILVER D 30/500	1121720450	on request			3280	115.8	196,8	8	116					
	1121720451	on request	500	74	2970	104.9	178,2	10	145	1"	30	22	2038x884x1790 80.2x34.8x70.5	700 1561
	1121720452	on request			2390	84.4	143,4	13	188					

D = con essiccatore / with dryer  
 Alimentazione standard 400V/50Hz/3 / Standard input 400V/50Hz/3  
 Disponibili versioni / Version available: 230V/50Hz/3 - 220V/60Hz/3 - 380V/60Hz/3 - 460V/60Hz/3

# NEW SILVER 41 ÷ 52

Trasmissione a cinghia / *Belt drive*

## Compressori d'aria silenziosi rotativi a vite integrati

*Silent encapsulated rotary screw compressors*

HIGH EFFICIENCY  
MOTOR IE3

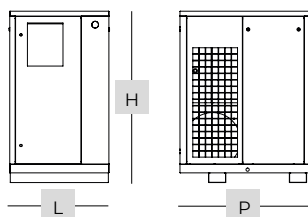

Modulo: solo compressore  
*Module: only compressor*

Type	Code											LxPxH	
		EAN CODE	dB (A)	l/min	CFM	m <sup>3</sup> /h	bar	psi	BSP	HP	kW	mm in	kg lb
NEW SILVER 41	8090387674	on request		4140	146	248	8	116					
	8090387682	on request	74	3620	128	217	10	145	1"	40	30	920x1195x1590 36,2x47,0x62,6	580 1279
	8090387690	on request		3150	111	189	13	188					
NEW SILVER 51	8090387708	on request		5320	188	319	8	116					
	8090387716	on request	75	4950	175	297	10	145	1"	50	37	920x1195x1590 36,2x47,0x62,6	600 1323
	8090387724	on request		4240	150	254	13	188					

Alimentazione standard 400V/50Hz/3 / *Standard input 400V/50Hz/3*  
Disponibili versioni / *Version available: 230V/50Hz/3 - 220V/60Hz/3 - 380V/60Hz/3 - 460V/60Hz/3*

# NEW SILVER 76 ÷ 101

Trasmissione a cinghia / *Belt drive*

## Compressori d'aria silenziosi rotativi a vite integrati

*Silent encapsulated rotary screw compressors*



NEW SILVER 61÷76

NEW SILVER 101

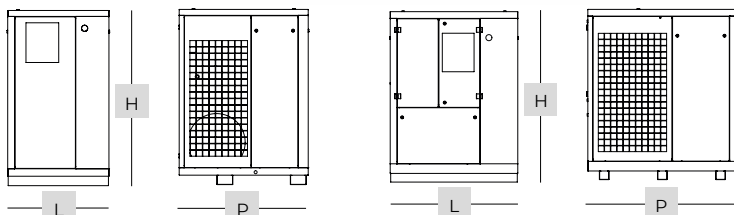

Modulo: solo compressore  
 Module: only compressor

Type	Code							LxPxH					
		EAN CODE	dB (A)	l/min	CFM	m <sup>3</sup> /h	bar	psi	BSP	HP	kW	mm in	kg lb
NEW SILVER 61	8090387765	on request		7100	251	426	8	116					
	8090387773	on request	75	6100	215	366	10	145	1 1/2"	60	45	1020x1300x1765	920
	8090387781	on request		5300	187	318	13	188				40,2x51,2x69,5	2028
NEW SILVER 76	8090387799	on request		9100	321	546	8	116					
	8090387807	on request	76	7900	279	474	10	145	1 1/2"	75	55	1020x1300x1765	1000
	8090387815	on request		6600	233	396	13	188				40,2x51,2x69,5	2205
NEW SILVER 101	8090387823	on request		12400	438	744	8	116					
	8090387831	on request	76	10800	381	648	10	145	2"	100	75	1325x1550x1800	1325
	8090387849	on request		9200	325	552	13	188				52,2x61,0x70,9	2921

Alimentazione standard 400V/50Hz/3 / Standard input 400V/50Hz/3  
 Disponibili versioni / Version available: 380V/60Hz/3 - 460V/60Hz/3

# NEW SILVER SD Inverter

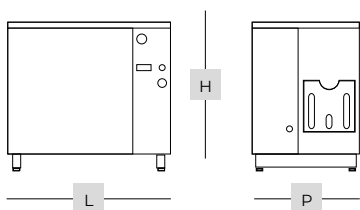

Modulo: solo compressore  
Module: only compressor

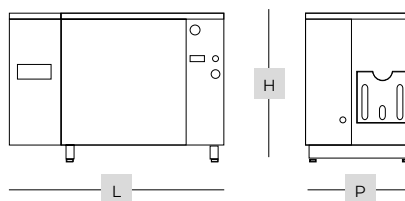

Modulo: compressore + essiccatore  
Module: compressor + dryer

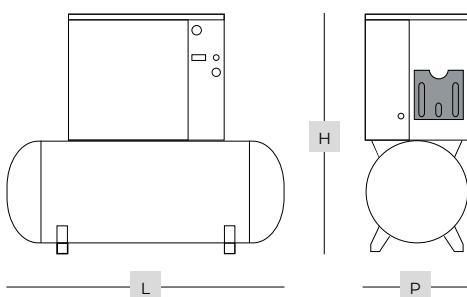

Modulo: compressore + serbatoio  
Module: compressor + tank

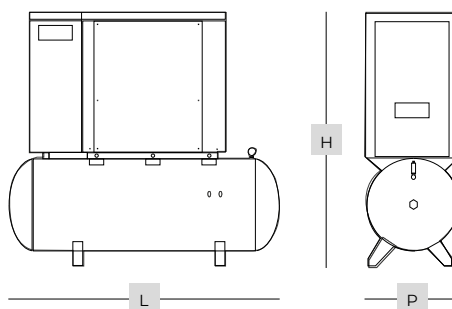

Modulo: compressore + serbatoio + essiccatore  
Module: compressor + tank + dryer



Type	Code	EAN CODE	l	dB (A)	min			max			bar	psi	BSP	HP	kW	LxPxH	
					l/min	CFM	m <sup>3</sup> /h	l/min	CFM	m <sup>3</sup> /h						mm	kg
NEW SILVER 10 SD	on request	on request			220	7.7	13,2	1050	37	63	8	116					
	1121730336	on request	-	64	200	7	12	950	33.5	57	10	145	1/2"	10	7,5	994x672x827	254
	on request	on request			180	6.3	10,8	700	24.7	42	13	188				39.1x26.5x32.6	565
NEW SILVER 15 SD	on request	on request			320	11.3	19,2	1560	55.1	93,6	8	116					
	1121720868	on request	-	65	300	10.6	18	1430	50.5	85,8	10	145	3/4"	15	11	1130x762x926	280
	on request	on request			260	9.2	15,6	1210	42.7	72,6	13	188				44.5x30x36.5	617
NEW SILVER 20 SD	on request	on request			340	12	20,4	2010	71	120,6	8	116					
	1121720869	on request	-	67	320	11.3	19,2	1900	67.1	114	10	145	3/4"	20	15	1130x762x926	310
	on request	on request			280	10	16,8	1670	59	100,2	13	188				44.5x30x36.5	683
NEW SILVER D 10 SD	on request	on request			220	7.7	13,2	1050	37	63	8	116					
	1121730337	on request	-	64	200	7	12	950	33.5	57	10	145	1/2"	10	7.5	1252x672x827	290
	on request	on request			180	6.3	10,8	700	24.7	42	13	188				49.3x26.5x32.6	644
NEW SILVER D 15 SD	on request	on request			320	11.3	19,2	1560	55.1	93,6	8	116					
	1121720870	on request	-	65	300	10.6	18	1430	50.5	85,8	10	145	3/4"	15	11	1397x762x926	320
	on request	on request			260	9.2	15,6	1210	42.7	72,6	13	188				55x30x36.5	706
NEW SILVER D 20 SD	on request	on request			340	12	20,4	2010	71	120,6	8	116					
	1121720871	on request	-	67	320	11.3	19,2	1900	67.1	114	10	145	3/4"	20	15	1397x762x926	345
	on request	on request			280	10	16,8	1670	59	100,2	13	188				55x30x36.5	761
NEW SILVER 10/300 SD	on request	on request			220	7.7	13,2	1050	37	63	8	116					
	1121730334	on request	270	64	200	7	12	950	33.5	57	10	145	1/2"	10	7,5	1631x700x1353	305
	on request	on request			180	6.3	10,8	700	24.7	42	13	188				64,2x27.6x53.3	678
NEW SILVER 10/500 SD	on request	on request			220	7.7	13,2	1050	37	63	8	116					
	1121730335	on request	500	64	200	7	12	950	33.5	57	10	145	1/2"	10	7,5	2038x700x1446	330
	on request	on request			180	6.3	10,8	700	24.7	42	13	188				80.2x27.6x56.9	734
NEW SILVER 15/500 SD	on request	on request			320	11.3	19,2	1560	55.1	93,6	8	116					
	1121720872	on request	500	65	300	10.6	18	1430	50.5	85,8	10	145	3/4"	15	11	2038x762x1547	385
	on request	on request			260	9.2	15,6	1210	42.7	72,6	13	188				80.2x30x60.9	849
NEW SILVER 20/500 SD	on request	on request			340	12	20,4	2010	71	120,6	8	116					
	1121720873	8020119150115	500	67	320	11.3	19,2	1900	67.1	114	10	145	3/4"	20	15	2038x762x1547	430
	on request	on request			280	10	16,8	1670	59	100,2	13	188				80.2x30x60.9	948
NEW SILVER D 10/300 SD	on request	on request			220	7.7	13,2	1050	37	63	8	116					
	1121730340	on request	270	64	200	7	12	950	33.5	57	10	145	1/2"	10	7,5	1631x700x1446	365
	on request	on request			180	6.3	10,8	700	24.7	42	13	188				64,2x27.6x56.9	811
NEW SILVER D 10/500 SD	on request	on request			220	7.7	13,2	1050	37	63	8	116					
	1121730338	on request	500	64	200	7	12	950	33.5	57	10	145	1/2"	10	7.5	2038x700x1446	390
	on request	on request			180	6.3	10,8	700	24.7	42	13	188				80.2x27.6x56.9	866
NEW SILVER D 15/500 SD	on request	on request			320	11.3	19,2	1560	55.1	93,6	8	116					
	1121720874	on request	500	65	300	10.6	18	1430	50.5	85,8	10	145	3/4"	15	11	2038x762x1547	430
	on request	on request			260	9.2	15,6	1210	42.7	72,6	13	188				80.2x30x60.9	948
NEW SILVER D 20/500 SD	on request	on request			340	12	20,4	2010	71	120,6	8	116					
	1121720875	on request	500	67	320	11.3	19,2	1900	67.1	114	10	145	3/4"	20	15	2038x762x1547	575
	on request	on request			280	10	16,8	1670	59	100,2	13	188				80.2x30x60.9	1268

Alimentazione standard 400V/50Hz/3 / Standard input 400V/50Hz/3  
 Disponibili versioni / Version available: 380V/60Hz/3 - 460V/60Hz/3

# AIRBLOK

## Compressori d'aria silenziosi rotativi a vite

*Silent rotary screw air compressors*

HIGH EFFICIENCY  
MOTOR IE3



La serie FIAC di compressori d'aria rotativi a vite con traino a cinghia AIRBLOK 7,5 -150 HP, integra soluzioni tecniche innovative, frutto di un'analisi approfondita delle esigenze industriali moderne, con il conseguente risultato di macchine potenti, affidabili, di semplice utilizzo e con minimi costi di manutenzione.

La disposizione ottimizzata e la scelta di alta qualità dei principali componenti, permette di fornire la migliore qualità dell'aria con la massima efficienza energetica unita ad una elevata silenziosità di funzionamento.

*FIAC belt driven rotary screw compressors of AIRBLOK 7,5-150 HP series, integrate technical innovations which are the result of a thorough analysis of modern industrial requirements, resulting in a powerful, reliable, easy to use machines with minimum maintenance.*

*The excellent layout and the top quality of the main components allows to deliver the very best in air quality with the best energy efficiency combined to a very low noise work.*

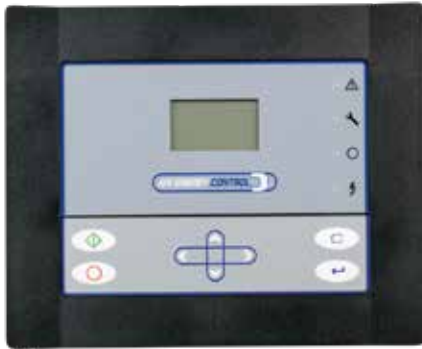

### Fiac Air Energy Control 3

Microprocessore ad architettura industriale sicuro ed efficiente.

Gestione e controllo totale dei parametri funzionali.

Display a cristalli liquidi con visualizzazione istantanea dei parametri durante le operazioni:

- Pressione di lavoro
- Temperatura olio
- Impostazione della pressione max/min.
- Gestione intelligente del ciclo di scarico
- Organizer: cicli di lavoro giornalieri, periodi di inattività.
- Programmazione tempistiche delle manutenzioni.
- Controllo remoto Start/Stop.
- Visualizzazione e registrazione degli allarmi di avvertimento e di stop.
- Gestione di impianti multiunità funzione MASTER/SLAVE.

### *Fiac Air Energy Control 3*

*Microprocessor of robust architecture safe and reliable.*

*Management and total control of the compressor operating parameters.*

*LCD display Instantaneous parameters displayed during operation:*

- *Working pressure*
- *Oil temperature*
- *Max. and min. pressure setting.*
- *Intelligent unload cycle management.*
- *Organizer: program of daily working cycles and periods of inactivity.*
- *Programmed maintenances schedule.*
- *Remote Start/Stop.*
- *Warning and stop alarms display and memorization.*
- *Management of multiunits plant: feature MASTER / SLAVE.*



### Componenti elettrici

Motori ad alta efficienza IE3.

Classe di protezione IP55, classe di isolamento F.

Cabina di controllo ventilata.

### *Electric components*

*High efficiency motor IE3.*

*Protection class IP55, insulation Class F.*

*Ventilated control cabinet.*



# AIRBLOK BD

## Compressori d'aria super silenziosi rotativi a vite con trasmissione a cinghia

*Belt drive super silent rotary screw air compressors*

HIGH EFFICIENCY  
MOTOR IE3



I compressori FIAC rotativi a vite, serie AIRBLOK BD 703-1002, sono caratterizzati da un accoppiamento tra motore elettrico e gruppo vite ad alto rendimento, con bassa velocità di rotazione.

L'utilizzo di pulegge in ghisa ad accoppiamento conico, assicura stabilità nella trasmissione del moto, basse sollecitazioni meccaniche e facilità degli interventi di manutenzione.

La disposizione ottimizzata dei componenti principali oltre a favorire lo scambio termico, l'efficienza del sistema di ventilazione forzata rende inoltre la manutenzione rapida ed economica, quest'ultima coadiuvata dalla facile accessibilità garantita da un sistema di pannelli mobili provvisti di serrature a norma.

Particolare attenzione si è prestata in fase di progettazione per rendere semplice l'installazione.

*FIAC rotary screw compressors of the AIRBLOK BD 703-1002 series are characterised by the coupling between the electric motor and high performance air end with optimal rotation speed.*

*The cast-iron conical coupling pulley ensure the transmission stability, low mechanical stress and easy maintenance operations.*

*The excellent layout of the easy maintenance the efficiency of the forced ventilation system ensure the heat exchange as well as making maintenance quick and economical thanks to the easy access guaranteed by a system of mobile panels equipped with safety locks.*

*During the design phase, deep attention was given to make simple machine installation.*



## Unità di compressione ad alta efficienza

Unità di compressione ad alta efficienza

Air-end progettato internamente con selezione ottimale della quantità di lobo (4/6), il tipo di profilo e le dimensioni del rotore garantiscono:

- Alta resa di aria compressa.
- Ottimale velocità del rotore
- Cuscinetti portanti e di spinta longevi ed efficienti.
- Altissima affidabilità.

### High efficiency compression unit

In-house designed air end with optimal selection of lobe quantity (4/6), type of profile and rotor dimensions grant:

- High compressed air capacity.
- Optimum rotors speed.
- Long lived and efficient bearings.
- Very high reliability.

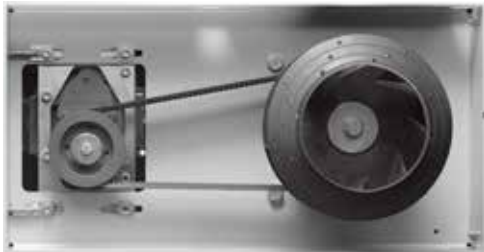

## Trasmissione a cinghia

Semplice serraggio della cinghia ruotando le viti (AIRBLOK BD 703-403).

Piastre a scorrimento guidato.

Tensionamento manuale (AIRBLOK BD 402 - 602).

Rapida e sicura sostituzione delle cinghie.

### Belt transmission

Simple belt tightening by turning the screws (AIRBLOK BD 703-403).

Guided sliding along plate.

Manual belt tensioning (AIRBLOK BD 502-602).

Quick and safe belt maintenance.



## Efficace elettroventola radiale

Silenziosità.

Potenza.

Elevata prevalenza.

Elevato ricambio d'aria all'interno del compressore.

### Powerful radial electrofan

Silent.

Powerful.

High prevalence.

High air exchange inside the cabinet.

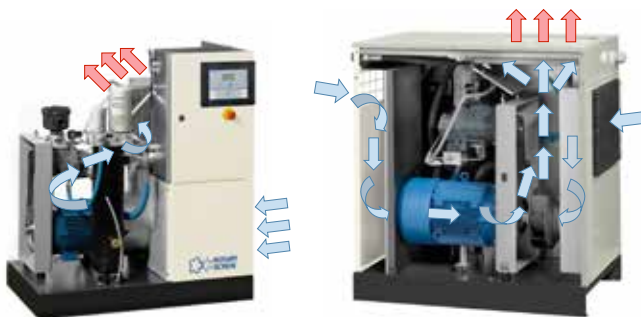

## Sistema di ventilazione e raffreddamento

Radiatori aria/olio in alluminio ad ampia superficie radiante.

Sistema di ventilazione che garantisce una corretta refrigerazione dei circuiti fluidodinamici.

Limitato incremento della temperatura dell'aria compressa in uscita rispetto alla temperatura ambiente.

Prefiltro a fibre intrecciate estraibile per facile pulizia.

### Efficient cooling system and ventilation

Aluminium cooler with large radiating surfaces.

Ventilation system keep the fluid dynamic circuits correctly cooled.

Removable fiber crossed pre-filter for easy cleaning.

Limited outlet compressed air temperature respect to ambient temperature.



## Efficace sistema di separazione olio a 3 stadi

Separazione acqua/olio mediante centrifugazione nel serbatoio separatore.

Separazione gravitazionale attraverso inversione della direzione del flusso.

Cartuccia o filtro coalescente ad alta efficienza.

### Optimized separation system: 3 stages

Separation oil/air by centrifugal force in the separator tank.

Gravitational separation through reversal of flow direction.

High efficiency coalescent in cartridge.

# AIRBLOK BD 703 ÷ 602

Trasmissione a cinghia / *Belt drive*

**Compressori d'aria super silenziosi rotativi a vite con trasmissione a cinghia**  
*Belt drive super silent rotary screw air compressors*

HIGH EFFICIENCY  
MOTOR IE3

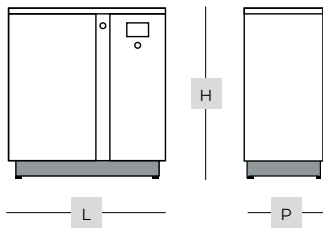

**AIRBLOK 703 ÷ 203**

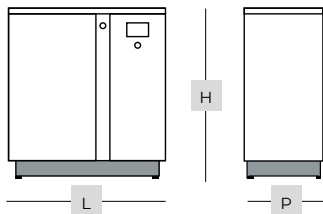

**AIRBLOK 253 ÷ 403**

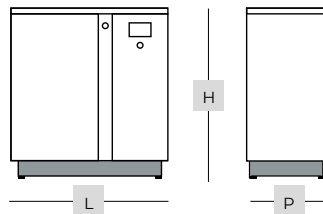

**AIRBLOK 502 ÷ 602**



Type	Code								LxPxH				
		EAN CODE	dB (A)	l/min	CFM	m <sup>3</sup> /h	bar	psi	BSP	HP	kW	mm in	kg lb
AIRBLOK 703 BD	4152026070	on request	62	880	31.1	52,8	8	116	3/4"	7,5	5,5	1065x615x1070	241
	4152026071	on request		700	24.7	42,0	10	145				41.9x24.2x42.1	531
AIRBLOK 103 BD	4152026072	on request	63	1240	43.8	74,4	8	116	3/4"	10	7,5	1065x615x1070	246
	4152026073	on request		1080	38.1	64,8	10	145				41.9x24.2x42.1	542
	4152026074	on request		830	29.3	49,8	13	188					
AIRBLOK 153 BD	4152026075	on request	65	1675	59.2	100,5	8	116	3/4"	15	11	1065x615x1070	266
	4152026076	on request		1510	53.3	90,6	10	145				41.9x24.2x42.1	586
	4152026077	on request		1210	42.7	72,6	13	188					
AIRBLOK 203 BD	4152026232	on request	67	2330	82.3	139,8	8	116	3/4"	20	15	1065x615x1070	270
	4152026233	on request		2110	74.5	126,6	10	145				41.9x24.2x42.1	595
	4152026234	on request		1690	59.7	101,4	13	188					
AIRBLOK 253 BD	4152026235	on request	69	3110	109.8	186,6	8	116	1"	25	18,5	1130x780x1220	361
	4152026236	on request		2720	96.1	163,2	10	145				44.5x30.7x48.0	796
	4152026237	on request		2300	81.2	138,0	13	188					
AIRBLOK 303 BD	4152026238	on request	70	3650	128.9	219,0	8	116	1"	30	22	1130x780x1220	377
	4152026239	on request		3240	114.4	194,4	10	145				44.5x30.7x48.0	831
	4152026240	on request		2770	97.8	166,2	13	188					
AIRBLOK 403 BD	4152026394	on request	71	4326	152.8	259,6	8	116	1"	40	30	1130x780x1220	405
	4152026395	on request		3900	137.7	234,0	10	145				44.5x30.7x48.0	893
	4152026396	on request		3436	121.3	206,2	13	188					
AIRBLOK 502 BD	1121680628	on request	65	5670	200	340	8	116	1 1/4"	50	37	1500x1000x1450	715
	1121680457	on request		5120	181	307	10	145				59.1x39.4x57.1	1576
	1121680629	on request		4460	157	267,6	13	188					
AIRBLOK 602 BD	1121680630	on request	65	6850	242	411	8	116	1 1/4"	60	45	1500x1000x1450	778
	1121680460	on request		6190	219	371	10	145				59.1x39.4x57.1	1715
	1121680631	on request		5530	195	332	13	188					

Alimentazione standard 400V/50Hz/3 - 230V/50Hz/3 - 230V/60Hz/3 - 208-230-460/60Hz/3 - 575/60Hz/3 - 380-440/60Hz/3  
 Standard input 400V/50Hz/3 - 230V/50Hz/3 - 230V/60Hz/3 - 208-230-460/60Hz/3 - 575/60Hz/3 - 380-440/60Hz/3

# AIRBLOK BD DRY

Trasmissione a cinghia / *Belt drive*

## Compressori d'aria silenziosi rotativi a vite con trasmissione a cinghia con essiccatore integrato

*Belt drive silent rotary screw air compressors with integrated dryer*

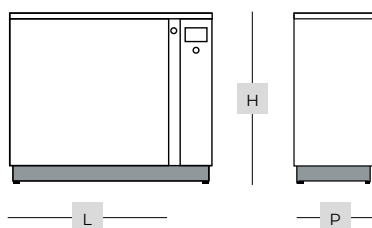

**AIRBLOK 703 ÷ 203 BD**

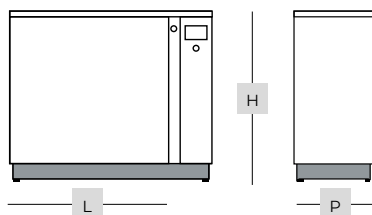

**AIRBLOK 253 ÷ 403 BD**



Soluzione Airblok per aria compressa: compressore rotativo a vite con essiccatore ad aria serie TDRY a ciclo frigorifero integrato, scarico condensa automatico e valvola e filtro ad aria coalescente ad alta efficienza.

*Airblok solution for treated compressed air: rotary screw compressor with integrated refrigerator air dryer TDRY series, automatic condensate drain valve and high-efficient coalescent air filter.*

Type	Code										LxPxH				
	EAN CODE		dB (A)	l/min	CFM	m <sup>3</sup> /h	bar	psi	BSP	HP	kW	mm in	kg lb		
AIRBLOK 703 BD DRY	4152026078	on request	62	880	31.1	52,8	8	116	3/4"	7,5	5,5	1065x615x1070	268		
	4152026079	on request		700	24.7	42,0	10	145				41.9x24.2x42.1	591		
AIRBLOK 103 BD DRY	4152026080	on request	63	1240	43.8	74,4	8	116	3/4"	10	7,5	1065x615x1070	276		
	4152026081	on request		1080	38.1	64,8	10	145						41.9x24.2x42.1	608
	4152026082	on request		830	29.3	49,8	13	188							
AIRBLOK 153 BD DRY	4152026083	on request	65	1675	59.2	100,5	8	116	3/4"	15	11	1065x615x1070	296		
	4152026084	on request		1510	53.3	90,6	10	145						41.9x24.2x42.1	653
	4152026085	on request		1210	42.7	72,6	13	188							
AIRBLOK 203 BD DRY	4152026241	on request	67	2330	82.3	139,8	8	116	3/4"	20	15	1065x615x1070	297		
	4152026242	on request		2110	74.5	126,6	10	145						41.9x24.2x42.1	655
	4152026243	on request		1690	59.7	101,4	13	188							
AIRBLOK 253 BD DRY	4152026244	on request	69	3110	109.8	186,6	8	116	1"	25	18,5	1585x780x1220	434		
	4152026245	on request		2720	96.1	163,2	10	145						62.4x30.7x48	957
	4152026246	on request		2300	81.2	138,0	13	188							
AIRBLOK 303 BD DRY	4152026247	on request	70	3650	128.9	219,0	8	116	1"	30	22	1585x780x1220	450		
	4152026248	on request		3240	114.4	194,4	10	145						62.4x30.7x48	992
	4152026249	on request		2770	97.8	166,2	13	188							
AIRBLOK 403 BD DRY	4152026397	on request	71	4326	152.8	259,6	8	116	1"	40	30	1585x780x1220	478		
	4152026398	on request		3900	137.7	234,0	10	145						62.4x30.7x48	1054
	4152026399	on request		3436	121.3	206,2	13	188							

Alimentazione standard 400V/50Hz/3 - 230V/50Hz/3 - 230V/60Hz/3 - 208-230-460/60Hz/3 - 575/60Hz/3 - 380-440/60Hz/3  
 Standard input 400V/50Hz/3 - 230V/50Hz/3 - 230V/60Hz/3 - 208-230-460/60Hz/3 - 575/60Hz/3 - 380-440/60Hz/3

# AIRBLOK DR

## Compressori d'aria rotativi a vite super silenziosi con trasmissione ad ingranaggi

*Gear drive super silent rotary screw air compressors*

HIGH EFFICIENCY  
MOTOR IE3



I compressori FIAC rotativi a vite con trasmissione ad ingranaggi della serie AIRBLOK DR sono la risposta concreta ai requisiti del mondo dell'aria compressa sempre esigenti.

L'eliminazione delle perdite di trasmissione, la bassa velocità dei rotori, l'uso di componenti di massima affidabilità e l'elettronica Air Energy Control 3+ garantiscono una lunga vita senza problemi e al minor costo d'esercizio.

*FIAC rotary screw gear drive compressors of the AIRBLOK DR series are the concrete answer at the requirements of compressed air world ever exigent.*

*The elimination of transmission losses, lower air end rotors speed, the use of components of maximum reliability and the electronic Air Energy Control 3+ allow the long life time without problems and the minimum operation cost.*





### Unità di compressione ad alta efficienza

La scelta ottimale del numero dei lobi, del tipo di profilo e delle dimensioni dei rotori consente:

- Alta resa di aria compressa.
- Ottima velocità di rotazione.
- Cuscinetti portanti e di spinta longevi ed efficienti.
- Altissima affidabilità.

#### *High efficiency compression unit*

*In-house designed air end with optimal selection of lobe quantity, type of profile and rotor dimensions grant:*

- *High compressed air capacity.*
- *Optimum rotors speed.*
- *Long lived and efficient bearings.*
- *Very high reliability.*



### Efficace sistema di separazione olio a 3 stadi

Separazione acqua/olio mediante centrifuga nel serbatoio separatore.  
Separazione gravitazionale attraverso inversione della direzione del flusso.  
Cartuccia o filtro coalescente ad alta efficienza.

#### *Optimized separation system: 3 stages*

*Separation oil/air by centrifugal force in the separator tank.  
Gravitational separation through reversal of flow direction.  
High efficiency coalescent in cartridge.*



### Regolatore di aspirazione

Valvola a farfalla a comando elettropneumatico.  
Valvola automatica di non-ritorno incorporata.  
Totale eliminazione di ritorno d'olio all'interno del filtro.

#### *Suction valve regulator*

*Electro-pneumatically butterfly valve.  
Incorporated automatic non-return valve.  
Total elimination of troublesome oil return problems within air filter.*



### Efficace elettroventola radiale

Silenziosità.  
Potenza.  
Bassa velocità periferica.  
Elevata prevalenza.  
Elevato ricambio d'aria in cabina.

#### *Powerful radial electrofan*

*Silent.  
Powerful.  
Low peripheral speed.  
High prevalence.  
High air exchange in cabinet.*



### Trasmissione a cinghia LESS LOSS

Ingranaggi precisamente lavorati  
Trasmissione con minima perdita di potenza.  
Nessuna manutenzione ordinaria  
Silenzioso  
Riduzione significativa dei carichi sull'albero.

#### *LESS LOSS transmission*

*Precisely machined gears  
Transmission with minimum loss of power.  
No ordinary maintenance.  
Noise less.  
Significant reduction of loads on the shaft.*

# AIRBLOK DR 752 ÷ 1002

Trasmissione diretta / *Direct drive*

**Compressori d'aria super silenziosi rotativi a vite con trasmissione diretta**

*Direct drive super silent rotary screw air compressors*

HIGH EFFICIENCY  
MOTOR IE3



Type	Code												
		EAN CODE	dB (A)	l/min	CFM	m <sup>3</sup> /h	bar	psi	BSP	HP	kW	mm in	kg lb
AIRBLOK 752 DR	1121680084	on request		9000	318	540	8	116					
	1121680085	on request	72	8050	284	483	10	145	1 1/2"	75	55	2200x1100x1950 86.6x43.3x76.7	1550 3417
	1121680086	on request		7300	255	438	13	188					
AIRBLOK 1002 DR	1121680087	on request		12600	445	756	8	116					
	1121680088	on request	73	10200	360	612	10	145	1 1/2"	100	75	2200x1100x1950 86.6x43.3x76.7	1750 3858
	1121680089	on request		8850	312	531	13	188					

Alimentazione standard 400V/50Hz/3 / Standard input 400V/50Hz/3  
Disponibili versioni / Version available: 380V/60Hz/3 - 460V/60Hz/3

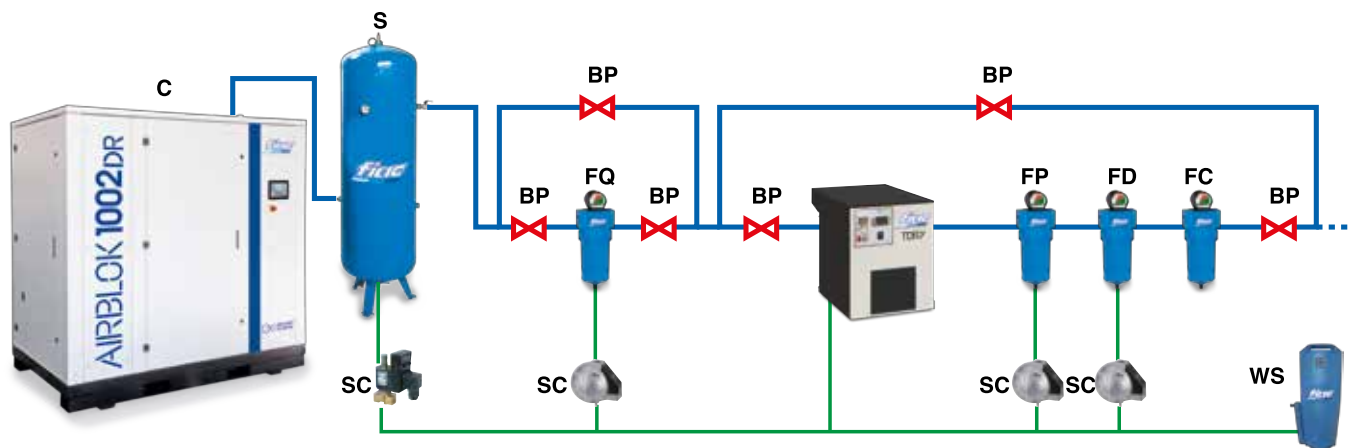

**C** = Compressore rotativo a vite / Rotary screw compressor  
**S** = Serbatoio d'aria / Air receiver  
**SC** = Scaricatore di condensa / Condensate drain valve  
**BP** = Bypass (Consente l'esclusione di parte di installazione per un'eventuale manutenzione) / (This allows you to shut-off part of the installation for possible maintenance requirements)

**FQ** = Filtro ad intercettazione / Interception filter  
**FP/FD** = Filtro a coalescenza / Coalescence filter  
**FC** = Filtro a carbone attivo / Activated carbon filter  
**WS** = Watersep (Separatore olio/acqua, garantisce una separazione totale) / (The oil/water separator guarantees total separation)

# AIRBLOK DR 1253 ÷ 1503

Trasmissione diretta / *Direct drive*

**Compressori d'aria super silenziosi rotativi a vite con trasmissione diretta**

*Direct drive super silent rotary screw air compressors*

HIGH EFFICIENCY  
MOTOR IE3

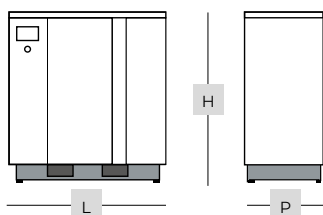

Type	Code									LxPxH			
		EAN CODE	dB (A)	l/min	CFM	m <sup>3</sup> /h	bar	psi	BSP	HP	kW	mm in	kg lb
AIRBLOK 1253 DR	on request	on request		16020	566	961	7,5	108					
	on request	on request	76	15960	564	958	8,5	123	2"	125	90	1860x1060x1630 73.2x41.7x64.2	1600 3527
	8152950311	on request		14100	498	846	10	145					
	on request	on request		12020	424	721	13	188					
AIRBLOK 1503 DR	on request	on request		20640	729	1238	7,5	108					
	on request	on request	73	19680	695	1181	8,5	123	2"	150	110	2333x1060x1630 91.9x41.7x64.2	1830 4034
	on request	on request		17880	631	1073	10	145					
	on request	on request		15120	534	907	13	188					

Alimentazione standard 400V/50Hz/3 / Standard input 400V/50Hz/3  
Disponibili versioni / Version available: 380V/60Hz/3 - 460V/60Hz/3

# AIRBLOK Inverter

## Compressori d'aria super silenziosi rotativi a vite con inverter

*Super silent rotary screw air compressors with speed drive control*

HIGH EFFICIENCY  
MOTOR IE3



### Tecnologia a inverter

I costi energetici ed i costi di manutenzione possono nell'insieme superare notevolmente la spesa dell'investimento iniziale.

La serie AIRBLOK SD, in particolare in impianti con consumo d'aria fluttuante, assicura l'abbattimento dei costi energetici in quanto è in grado di regolare la velocità di rotazione del motore elettrico, quindi la velocità del gruppo vite, in funzione del consumo aziendale di aria compressa.

Il compressore con inverter consente di mantenere la proporzionalità tra consumo energetico e consumo di aria, avvicinando il suo rendimento a quello ideale.

Dai grafici rappresentati di seguito, risulta evidente come l'energia consumata dal compressore con inverter è strettamente legata alla quantità di aria compressa richiesta, mentre nel sistema on/off manca una stretta correlazione tra i due valori.

### Speed drive control

*The combination of energy and maintenance costs may be considerably higher than the initial investment cost.*

*The AIRBLOK SD series, especially in plants with fluctuating air consumptions, ensures the reduction of energy costs because it can adjust the running speed of the electric motor and therefore the speed of the screw unit, based on the factory's consumption of compressed air.*

*The speed drive controlled compressor maintains the energy consumption and the air consumption proportioned, thus ensuring ideal performance.*

*From the following graphs, it is clear that the energy used by the speed drive control compressor depends on the quantity of compressed air requested, while in the on/off system there is no correlation between the two values.*

**Senza inverter**

*Without speed drive control*

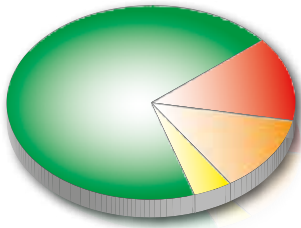

**Con inverter**

*With speed drive control*

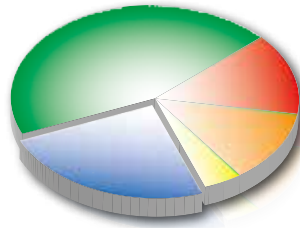

- Consumo di energia / Energy consumption
- Manutenzione / Maintenance
- Investimento / Investment
- Installazione / Installation
- Risparmio medio di energia pari al 35%  
Medium energy saving 35%

**Calcolate il vostro risparmio (x)**

Diversi studi hanno dimostrato che il tipico utilizzo dei compressori a vite è tra il 50% e il 70%. Nelle tabelle potete trovare i valori di energia consumata in percentuale relativi al reale utilizzo dei compressori con avviamento stella/triangolo e con azionamento con inverter. Con un semplice calcolo potete conoscere il vostro risparmio scegliendo un compressore a vite AIRBLOK SD.

**Plan your saving (x)**

*Several studies have shown that typical screw compressor load overtime to be 50-70%. on table above are indicated the value of energy consumption in percentage for real use of compressors star/delta start and speed drive control by inverter.*

*By a simple calculation, you can know your saving using a compressor AIRBLOK SD.*

$$x = T \cdot C \cdot P \cdot \frac{L}{E} + M + K$$

- T** = tempo totale di lavoro (n°ore di lavoro/giorno - n°giorni all'anno - 5 anni)  
*total working time (n° working hours per day - n° working day per years - 5 year)*
- C** = costo energia kW/ora / *energy cost kWh*
- P** = potenza in kW del compressore / *compressor kw power*
- L** = percentuale energia consumata / *percentage of energy consumption*
- E** = efficienza del motore / *motor efficiency*
- M** = costo manutenzione per 5 anni / *cost of maintenance per 5 years*
- K** = costo dell'investimento / *cost of investment*



**Richiesta aria / Air requirement**

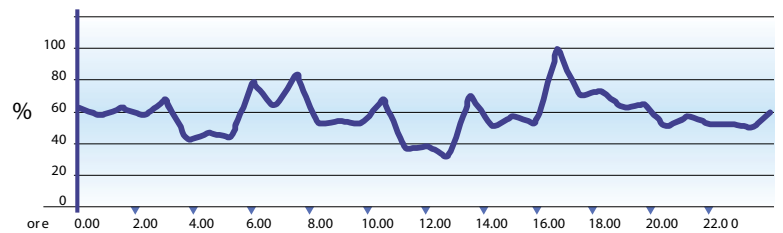

**Fiac Air Energy Control 3+**

Microprocessore ad architettura industriale sicuro ed efficiente. Gestione e controllo totale dei parametri funzionali.

**Fiac Air Energy Control 3+**

*Microprocessor of robust architecture safe and reliable. Management and total control of the compressor operating parameters.*

**Potenza consumata  
Power consumption**

per compressore standard - efficienza motore 85-90%  
*for D.O.L. compressors - motor efficiency 85-90%*

<b>LOAD</b>	100	90	80	70	60	50	40
<b>POWER</b>	100%	97%	94%	91%	88%	85%	82%

per compressore con inverter - efficienza motore 94%  
*for speed drive compressors - motor efficiency 94%*

<b>LOAD</b>	100	90	80	70	60	50	40
<b>POWER</b>	100%	89%	78%	68%	57%	47%	37%

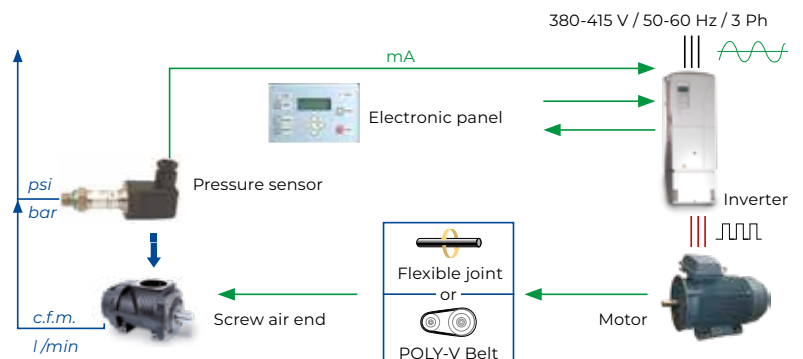

# AIRBLOK BD/SD 103 ÷ 602 Inverter

Trasmissione a cinghia / *Belt drive*

## Compressori d'aria super silenziosi rotativi a vite con inverter

*Super silent rotary screw air compressors with speed drive control*

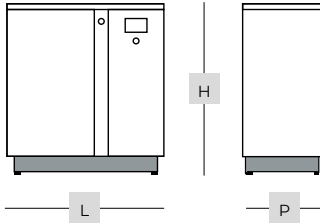

**AIRBLOK 103 ÷ 203**

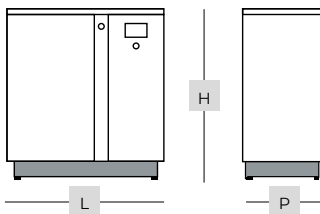



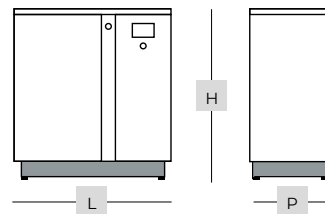





**AIRBLOK 253 ÷ 403**



**AIRBLOK 502 ÷ 602**



Type	Code									LxPxH								
		EAN CODE	dB (A)	l/min	CFM	m <sup>3</sup> /h	l/min	CFM	m <sup>3</sup> /h	bar	psi	BSP	HP	kW	mm in	kg lb		
AIRBLOK 103 BD-SD 5-13	4152026102	on request	63	125	4.4	7,5	1200	42.4	72,0	7,5	109	3/4"	10	7,5	1065x615x1095	255		
		on request		335	11.8	20,1	1040	36,7	62,4	9,5	138						41.9x24.2x43.1	562
		on request		415	14.7	24,9	825	29,1	49,5	12,5	181							
AIRBLOK 153 BD-SD 5-13	4152026103	on request	65	380	13.4	22,8	1750	61,8	105,0	7,5	109	3/4"	15	11	1065x615x1095	275		
		on request		410	14.5	24,6	1440	50,9	86,4	9,5	138						41.9x24.2x43.1	606
		on request		450	15.9	27,0	1200	42,4	72,0	12,5	181							
AIRBLOK 203 BD-SD 5-10	4152026268	on request	67	620	21.9	37,2	2310	81,6	138,6	7,5	109	3/4"	20	15	1065x615x1095	280		
		on request		670	23.7	40,2	1990	70,3	119,4	9,5	138						41.9x24.2x43.1	617
AIRBLOK 203 BD-SD 5-13	4152026269	on request	67	485	17.1	29,1	1865	65,9	111,9	9,5	138	3/4"	20	15	1065x615x1095	280		
		on request		610	21.5	36,6	1725	60,9	103,5	12,5	181						41.9x24.2x43.1	617
AIRBLOK 253 BD-SD 5-10	4152026270	on request	69	575	20.3	34,5	2935	103,6	176,1	7,5	109	1"	25	18,5	1130x780x1220	370		
		on request		770	27.2	46,2	2615	92,3	156,9	9,5	138						44.5x30.7x48	816
AIRBLOK 253 BD-SD 5-13	4152026271	on request	69	490	17.3	29,4	2465	87,1	147,9	9,5	138	1"	25	18,5	1130x780x1220	370		
		on request		610	21.5	36,6	2155	76,1	129,3	12,5	181						44.5x30.7x48	816
AIRBLOK 303 BD-SD 5-10	4152026272	on request	70	625	22.1	37,5	3390	119,7	203,4	7,5	109	1"	30	22	1130x780x1220	370		
		on request		865	30.5	51,9	3080	108,8	184,8	9,5	138						44.5x30.7x48	816
AIRBLOK 303 BD-SD 5-13	4152026273	on request	70	530	18.7	31,8	3050	107,7	183,0	9,5	138	1"	30	22	1130x780x1220	370		
		on request		755	26.7	45,3	2510	88,6	150,6	12,5	181						44.5x30.7x48	816
AIRBLOK 403 BD-SD 5-10	4152026406	on request	71	1456	51.4	87,4	4400	155,4	264,0	7,5	109	1"	40	30	1130x780x1220	370		
		on request		1804	63.7	108,2	3997	141,2	239,8	9,5	138						44.5x30.7x48	816
AIRBLOK 403 BD-SD 5-13	4152026407	on request	71	1600	56.5	96,0	3792	133,9	227,5	9,5	138	1"	40	30	1130x780x1220	370		
		on request		1347	47.6	80,8	3245	114,6	194,7	12,5	181						44.5x30.7x48	816
AIRBLOK 502 BD-SD	1121680635	on request	65	2140	75.4	128,4	6085	215	365	8	116	1 1/4"	50	37	1500x1000x1450	971		
	1121680459	on request		1940	68.4	116,4	5530	195	331,8	10	145						58.5x39.4x56.5	2141
	1121680636	on request		1830	64.7	109,8	4800	169	288	13	188							
AIRBLOK 602 BD-SD	1121680637	on request	65	2600	91.8	156	7400	261	444	8	116	1 1/4"	60	45	1500x1000x1450	1033		
	1121680461	on request		2400	84.8	144	6500	229	390	10	145						58.5x39.4x56.5	2277
	1121680638	on request		2100	74.2	126	5500	194	330	13	188							

# AIRBLOK BD/SD DRY 103 ÷ 403

Inverter 

Trasmissione a cinghia / Belt drive



**Compressori d'aria silenziosi rotativi a vite con trasmissione a cinghia con essiccatore integrato**

*Belt drive silent rotary screw air compressors with integrated dryer*

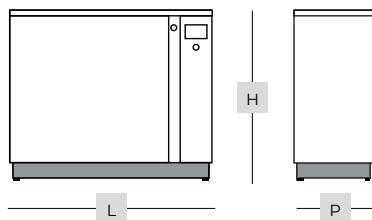



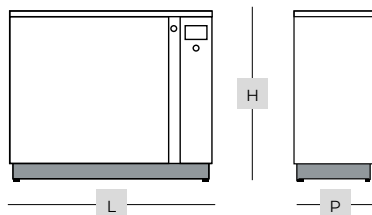





**AIRBLOK 103 ÷ 203**



**AIRBLOK 253 ÷ 403**



Type	Code	EAN CODE	 dB (A)	 min		 max		 bar	 psi	 BSP	 HP	kW	LxPxH mm in	 kg lb		
				l/min	CFM	m <sup>3</sup> /h	l/min								CFM	m <sup>3</sup> /h
AIRBLOK 103 BD/SD DRY 5-13	4152026104	on request		125	4.4	7.5	1200	42.4	72.0	7.5	109		1065x615x1095 41.9x24.2x43.1	285 628		
		on request	63	335	11.8	20.1	1040	36.7	62.4	9.5	138	3/4"			10	7.5
		on request		415	14.7	24.9	825	29.1	49.5	12.5	181					
AIRBLOK 153 BD/SD DRY 5-13	4152026105	on request		380	13.4	22.8	1750	61.8	105.0	7.5	109		1065x615x1095 41.9x24.2x43.1	305 672		
		on request	65	410	14.5	24.6	1440	50.9	86.4	9.5	138	3/4"			15	11
		on request		450	15.9	27.0	1200	42.4	72.0	12.5	181					
AIRBLOK 203 BD-SD DRY 5-10	4152026274	on request		620	21.9	37.2	2310	81.6	138.6	7.5	109		1065x615x1095 41.9x24.2x43.1	307 677		
		on request	67	670	23.7	40.2	1990	70.3	119.4	9.5	138	3/4"			20	15
AIRBLOK 203 BD-SD DRY 5-13	4152026275	on request		485	17.1	29.1	1865	65.9	111.9	9.5	138		1065x615x1095 41.9x24.2x43.1	307 677		
		on request	67	610	21.5	36.6	1725	60.9	103.5	12.5	181	3/4"			20	15
AIRBLOK 253 BD-SD DRY 5-10	4152026276	on request		575	20.3	34.5	2935	103.6	176.1	7.5	109		1585x780x1220 62.4x30.7x48	445 981		
		on request	69	770	27.2	46.2	2615	92.3	156.9	9.5	138	1"			25	18.5
AIRBLOK 253 BD-SD DRY 5-13	4152026277	on request		490	17.3	29.4	2465	87.1	147.9	9.5	138		1585x780x1220 62.4x30.7x48	445 981		
		on request	69	610	21.5	36.6	2155	76.1	129.3	12.5	181	1"			25	18.5
AIRBLOK 303 BD-SD DRY 5-10	4152026278	on request		625	22.1	37.5	3390	119.7	203.4	7.5	109		1585x780x1220 62.4x30.7x48	490 1080		
		on request	70	865	30.5	51.9	3080	108.8	184.8	9.5	138	1"			30	22
AIRBLOK 303 BD-SD DRY 5-13	4152026279	on request		530	18.7	31.8	3050	107.7	183.0	9.5	138		1585x780x1220 62.4x30.7x48	490 1080		
		on request	70	755	26.7	45.3	2510	88.6	150.6	12.5	181	1"			30	22
AIRBLOK 403 BD-SD DRY 5-10	4152026408	on request		1456	51.4	87.4	4400	155.4	264.0	7.5	109		1585x780x1220 62.4x30.7x48	520 1146		
		on request	71	1804	63.7	108.2	3997	141.2	239.8	9.5	138	1"			40	30
AIRBLOK 403 BD-SD DRY 5-13	4152026409	on request		1600	56.5	96.0	3792	133.9	227.5	9.5	138		1585x780x1220 62.4x30.7x48	520 1146		
		on request	71	1347	47.6	80.8	3245	114.6	194.7	12.5	181	1"			40	30

Alimentazione standard 400V/50Hz/3 / Standard input 400V/50Hz/3

Disponibili versioni / Version available: 230V/50Hz/3 - 230V/60Hz/3 - 208-230-460/60Hz/3 - 575/60Hz/3 - 380-440/60Hz/3







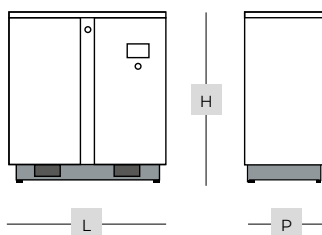

# AIRBLOK DR/SD 752 ÷ 1002 Inverter

Trasmissione diretta / *Direct drive*

## Compressori d'aria super silenziosi rotativi a vite con inverter

*Super silent rotary screw air compressors with speed drive control*



Type	Code	EAN CODE	 dB (A)	 min			 max			 bar	 psi	 BSP	 HP	 kW	LxPxH mm in	 kg lb
				l/min	CFM	m <sup>3</sup> /h	l/min	CFM	m <sup>3</sup> /h							
AIRBLOK 752 DR-SD	1121690225	on request		2950	104	177	9000	319	540	8	116					
	1121690226	on request	72	2830	100	170	8050	284	483	10	145	1 1/2"	75	55	2200x1100x1950	1600
	on request	on request		2710	96	162,6	7300	258	438	13	188				86.6x43.3x76.7	3527
AIRBLOK 1002 DR-SD	1121690227	on request		2970	105	178,2	12600	445	756	8	116					
	1121690228	on request	73	2850	101	171	10200	350	612	10	145	1 1/2"	100	75	2200x1100x1950	1800
	on request	on request		2780	98	166,8	8850	313	531	13	188				86.6x43.3x76.7	3968

Alimentazione standard 400V/50Hz/3 / Standard input 400V/50Hz/3  
Disponibili versioni / Version available: 380V/60Hz/3 - 460V/60Hz/3











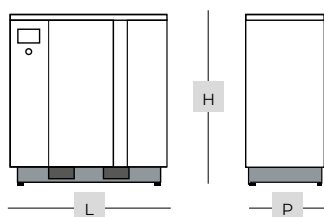

# AIRBLOK DR/SD 1253 ÷ 1503 Inverter

Trasmissione diretta / *Direct drive*

**Compressori d'aria super silenziosi rotativi a vite con inverter**

*Super silent rotary screw air compressors with speed drive control*



Type	Code	EAN CODE	 dB (A)	 min		 max		 bar	 psi	 BSP	 HP	 kW	LxPxH	 kg		
				l/min	CFM	m <sup>3</sup> /h	l/min								CFM	m <sup>3</sup> /h
AIRBLOK 1253 DR-SD 4-10	8152950312	on request	77	4600	162	276	16200	572	972	7	102	125	90	1860x1060x1630 73.2x41.7x64.2	1600 3527	
				4660	165	280	14190	501	851,4	9,5	138	2"	125			90
				3910	138	235	14470	511	868,2	7	102					
AIRBLOK 1253 DR-SD 4-13	on request	on request	76	3830	135	230	14190	501	851,4	9,5	138	125	90	1860x1060x1630 73.2x41.7x64.2	1600 3527	
				3727	132	224	12020	424	721,2	12,5	181					
AIRBLOK 1503 DR-SD 4-10	on request	on request	74	3610	127	217	19080	674	1144,8	7	102	150	110	2333x1060x1630 91.9x41.7x64.2	1600 3527	
				3910	138	235	17160	606	1029,6	9,5	138	2"	150			110
AIRBLOK 1503 DR-SD 4-13	on request	on request	73	3190	113	191	17160	606	1029,6	9,5	138	150	110	2333x1060x1630 91.9x41.7x64.2	1600 3527	
				3000	106	180	14220	502	853,2	12,5	181					

Alimentazione standard 400V/50Hz/3 / Standard input 400V/50Hz/3  
 Disponibili versioni / Version available: 380V/60Hz/3 - 460V/60Hz/3

# TDRY



## Essiccatori a ciclo frigorifero

Refrigeration dryers



### Caratteristiche del prodotto

#### Indicatore del PDP

Il funzionamento dell'essiccatore TDRY è controllato da una centralina elettronica che fornisce tutte le informazioni utili:

##### Dettagli tecnici:

- Stato dell'essiccatore a refrigerazione
- Stato della ventola
- Indicazione del punto di rugiada

##### Allarmi a display:

- Allarme per un punto di rugiada elevato o ridotto
- Guasto ventola (TDRY 12-77)
- Avvertimento di manutenzione

##### Pannello di controllo con contatto libero (su richiesta) per:

- Allarme PDP in remoto (TDRY 24-840)
- Temperatura elevata del refrigerante in remoto (TDRY 24-840)
- Guasto della ventola in remoto (TDRY 24-77)

#### Scarico capacitivo intelligente

L'intera gamma di essiccatori a refrigerazione è dotata di scaricatori capacitivi di condensa, una gamma che utilizza sensori elettronici per lo scarico della sola condensa e senza sprechi di aria compressa.

##### Vantaggi

- Viene scaricata solo l'acqua, non l'aria compressa
- Risparmio energetico
- Assenza di rumore e rispetto dell'ambiente

### Caratteristiche standard (per il TDRY 100-840)

##### Contatti liberi per:

- Avvio/arresto in remoto
- Allarme generale in remoto
- Allarme scarico in remoto

### Product features

#### PDP Indicator

The operation of the TDRY dryer is monitored by an electronic controller indicating all relevant information:

##### Technical details:

- Status of the refrigerant dryer
- Status of the fan
- Dewpoint indication

##### Alarm display:

- Alarm about high or low dewpoint
- Fan probe failure (TDRY 12-77)
- Service warning

##### Control panel with free contact (on request) for a:

- Remote PDP alarm (TDRY 24-840)
- Remote high refrigerant temperature (TDRY 24-840)
- Remote fan probe failure (TDRY 24-77)

#### Intelligent capacitive drain discharge

The full refrigerant dryer range is equipped with the capacity condensate drain, a range using electronic sensors to discharge only condensate and without wasting any compressed air.

##### Benefits

- Only water is discharged, no compressed air
- Energy saving
- No noise and environmental friendly

### Standard features (for il TDRY 100-840)

##### Free contacts for a:

- Remote start/stop
- Remote general alarm
- Remote drain alarm

## TDRY 4÷18

### Essiccatori a ciclo frigorifero

Refrigeration dryers



Type	Code						LxPxH				
	EAN CODE		l/min	CFM	m <sup>3</sup> /h	mbar	BSP	CL	mm in	kg lb	m <sup>3</sup>
TDRY 4	4102002780	on request	350	12	21	0,15	3/4" M	4	350 x 493 x 450 13,8 x 19,4 x 17,7	19 42	0,078
TDRY 6	4102002781	8020119147900	600	21	36	0,25	3/4" M	4	350 x 493 x 450 13,8 x 19,4 x 17,7	19 42	0,078
TDRY 9	4102002782	on request	850	30	51	0,25	3/4" M	4	350 x 493 x 450 13,8 x 19,4 x 17,7	20 44	0,078
TDRY 12	4102002783	8020119147924	1200	42	72	0,25	3/4" M	4	350 x 493 x 450 13,8 x 19,4 x 17,7	25 55	0,078
TDRY 18	4102002784	8020119147887	1825	64	110	0,30	3/4" M	4	350 x 493 x 450 13,8 x 19,4 x 17,7	27 60	0,078

## TDRY 24÷30

### Essiccatori a ciclo frigorifero

Refrigeration dryers



Type	Code						LxPxH				
	EAN CODE		l/min	CFM	m <sup>3</sup> /h	mbar	BSP	CL	mm in	kg lb	m <sup>3</sup>
TDRY 24	4102003277	8020119147894	2350	83	141	0,32	1"	4	370 x 498 x 764 14,6 x 19,6 x 30,1	44 97	0,141
TDRY 30	4102003278	8020119147917	3000	106	180	0,38	1"	4	370 x 498 x 764 14,6 x 19,6 x 30,1	44 97	0,141

**TDRY 36÷77****Essiccatori a ciclo frigorifero**

Refrigeration dryers



Type	Code		↔	Δp	∅	ISO 9001 AC1	LxPxH				
	EAN CODE	l/min	CFM	m <sup>3</sup> /h	mbar	BSP	CL	mm in	kg lb	m <sup>3</sup>	
TDRY 36	4102002826	on request	3600	127	216	0,18	1 1/2"	4	460 x 558 x 789 18,1 x 22,0 x 31,1	53 117	0,203
TDRY 41	4102002827	on request	4100	145	246	0,25	1 1/2"	4	460 x 558 x 789 18,1 x 22,0 x 31,1	60 132	0,203
TDRY 52	4102002828	on request	5200	184	312	0,18	1 1/2"	4	460 x 558 x 789 18,1 x 22,0 x 31,1	65 143	0,203
TDRY 65	4102002829	on request	6500	230	390	0,20	1 1/2"	4	580 x 588 x 899 22,8 x 23,1 x 35,4	80 176	0,307
TDRY 77	4102002830	on request	7700	272	462	0,27	1 1/2"	4	580 x 588 x 899 22,8 x 23,1 x 35,4	80 176	0,307

**TDRY 100÷180****Essiccatori a ciclo frigorifero**

Refrigeration dryers



Type	Code		↔	Δp	∅	ISO 9001 AC1	LxPxH				
	EAN CODE	l/min	CFM	m <sup>3</sup> /h	mbar	BSP	CL	mm in	kg lb	m <sup>3</sup>	
TDRY 100	4102002844	on request	10000	353	600	0,25	2"	4	735 x 898 x 962 28,9 x 35,4 x 37,9	128 282	0,635
TDRY 120	4102002845	on request	12000	424	720	0,30	2"	4	735 x 898 x 962 28,9 x 35,4 x 37,9	146 322	0,635
TDRY 150	4102002846	on request	15000	530	900	0,30	2"	4	735 x 898 x 962 28,9 x 35,4 x 37,9	158 348	0,635
TDRY 180	4102002847	on request	18000	636	1080	0,30	2"	4	735 x 898 x 962 28,9 x 35,4 x 37,9	165 364	0,635

## TDRY 240÷840



### Essiccatori a ciclo frigorifero

Refrigeration dryers



Type	Code		↔			Δp	⊘	ISO 8573-1 #CL5	LxPxH	📏	📦
		EAN CODE	l/min	CFM	m <sup>3</sup> /h	mbar	BSP	CL	mm in	kg lb	m <sup>3</sup>
TDRY 240	4102003118	on request	24000	848	1440	0,25	3"	4	1020 x 1023 x 1535 40,2 x 40,3 x 60,4	325 717	1,602
TDRY 300	4102003119	on request	30000	1059	1800	0,30	3"	4	1020 x 1023 x 1535 40,2 x 40,3 x 60,4	335 739	1,602
TDRY 350	4102003120	on request	35000	1236	2100	0,35	3"	4	1020 x 1023 x 1535 40,2 x 40,3 x 60,4	350 772	1,602
TDRY 450	4102002863	on request	45000	1589	2700	0,25	DN 125	4	1020 x 1121 x 1526 40,2 x 44,1 x 60,1	380 838	1,745
TDRY 500	4102002864	on request	50000	1766	3000	0,30	DN 125	4	1020 x 2099 x 1535 40,2 x 82,7 x 60,4	550 1213	3,286
TDRY 700	4102002865	on request	70000	2472	4200	0,25	DN 125	4	1020 x 2099 x 1535 40,2 x 82,7 x 60,4	600 1323	3,286
TDRY 840	4102002866	on request	84000	2966	5040	0,26	DN 125	4	1020 x 2099 x 1535 40,2 x 82,7 x 60,4	650 1433	3,286

# Essiccatori ad adsorbimento

## Adsorption dryers

### Trattamento dell'aria / Air treatment

#### HDK 83 ÷ 1666

Type	Code	↔	↻				LxPxH	📦
			EAN CODE	l/min	CFM	m <sup>3</sup> /h		
HDK 83	1120034356	on request	83	2.9	5	1/2"	300 x 120 x 350 117 x 47 x 136	7 15
HDK 166	1120034358	on request	166	5.9	10	1/2"	300 x 120 x 595 117 x 47 x 232	11 24
HDK 250	1120034359	on request	250	8.8	15	1/2"	300 x 120 x 855 117 x 47 x 333	15 33
HDK 416	1127560503	on request	416	14.7	25	1/2"	300 x 120 x 1385 117 x 47 x 540	24 53
HDK 583	1127560504	on request	583	20.6	35	1"	535 x 190 x 670 208 x 74 x 261	29 64
HDK 833	1127560505	on request	833	29.5	50	1"	535 x 190 x 925 208 x 74 x 360	38 84
HDK 1083	1120034362	on request	1083	38.2	65	1"	535 x 190 x 1175 208 x 74 x 458	48 107
HDK 1333	1120034363	on request	1333	47	80	1"	535 x 190 x 1435 208 x 74 x 559	57 127
HDK 1666	1127560508	on request	1666	58.9	100	1"	535 x 190 x 1685 208 x 74 x 657	67 149



Punto di rugiada HDK: -40°C (-70°C con diminuzione portata nominale del 30%) / HDK dew point: -40°C (-70°C with 30% reduction of the rated capacity)

#### HDA 2500 ÷ 16666

Type	Code			↔	↻				LxPxH	📦
	HDA-V (-20°C)	HDA-Q (-40°C)	HDA-S (-70°C)		l/min	CFM	m <sup>3</sup> /h	BSP		
HDA 2500	1120034366	1127560509	1120034367	2500	88.3	150	1"	770 x 600 x 1980 300 x 234 x 772	41 91	
HDA 3750	1120034369	1120034371	1120034372	3750	132.4	225	1 1/2"	770 x 600 x 1980 300 x 234 x 772	70 155	
HDA 5000	1120034373	1120034374	1120034375	5000	176.6	300	1 1/2"	770 x 600 x 1980 300 x 234 x 772	82 182	
HDA 6250	1120034376	1127560512	1120034377	6250	220.7	375	1 1/2"	950 x 700 x 2190 370 x 273 x 854	95 211	
HDA 9166	1120034381	1120034382	1120034383	9166	323.7	550	2"	950 x 700 x 2190 370 x 273 x 854	161 357	
HDA 10833	1120034384	1120034385	1120034386	10833	382.5	650	2"	950 x 700 x 2190 370 x 273 x 854	180 400	
HDA 14166	1120034387	1120034388	1120034389	14166	500.2	850	2"	1100 x 800 x 2350 429 x 312 x 916	190 422	
HDA 16666	1120034390	1120034391	1120034392	16666	588.5	1000	2 1/2"	1100 x 800 x 2350 429 x 312 x 916	201 446	



Identificare punto di rugiada: HDA-V (-20°C) - HDA-Q (40°C) - HDA-S (-70°C) / Identify dew point: HDA-V (-20°C) - HDA-Q (40°C) - HDA-S (-70°C)

# Aria respirabile / Breathable air

## Trattamento dell'aria / Air treatment

### BSK 83 ÷ 1666

Type	Code	↔		⊘		LxPxH	📦	
		EAN CODE	l/min	CFM	m³/h			BSP
BSK 83	1127560600	on request	83	2,9	5	1/2"	300 x 120 x 350 / 117 x 47 x 136	7 / 15
BSK 166	1120034643	on request	166	5,9	10	1/2"	300 x 120 x 595 / 117 x 47 x 232	11 / 24
BSK 250	1127560602	on request	250	8,8	15	1/2"	300 x 120 x 855 / 117 x 47 x 333	15 / 33
BSK 416	1127560603	on request	416	14,7	25	1/2"	300 x 120 x 1385 / 117 x 47 x 540	24 / 53
BSK 583	1120034650	on request	583	20,6	35	1"	535 x 190 x 670 / 208 x 74 x 261	29 / 64
BSK 833	1120034651	on request	833	29,5	50	1"	535 x 190 x 925 / 208 x 74 x 360	38 / 84
BSK 1083	1127560606	on request	1083	38,2	65	1"	535 x 190 x 1175 / 208 x 74 x 458	48 / 107
BSK 1333	1127560607	on request	1333	47	80	1"	535 x 190 x 1435 / 208 x 74 x 559	57 / 127
BSK 1666	1127560608	on request	1666	58,9	100	1"	535 x 190 x 1685 / 208 x 74 x 657	67 / 149



### BSA 2500 ÷ 6250

Type	Code	↔		⊘		LxPxH	📦	
		EAN CODE	l/min	CFM	m³/h			BSP
BSA 2500	1120034662	on request	2500	88.3	150	1"	770 x 600 x 1980 / 300 x 234 x 772	41 / 91
BSA 3750	1120034665	on request	3750	132.4	225	1-1/2"	770 x 600 x 1980 / 300 x 234 x 772	70 / 155
BSA 5000	1120034668	on request	5000	176.6	300	1-1/2"	770 x 600 x 1980 / 300 x 234 x 772	82 / 182
BSA 6250	1120034671	on request	6250	220.7	375	1-1/2"	950 x 700 x 2190 / 370 x 273 x 854	95 / 211



# Separatori di condensa

## Condensate separators

## Trattamento dell'aria / Air treatment

### EK 2000 ÷ 33300 \*

Type	Cod. filtro / Filter Code	↔		⊘	
		l/min	CFM	m³/h	BSP
EK 2000	1127210286	2000	71	120	3/8"
EK 2600	1127210287	2600	92	155	1/2"
EK 3900	1127210288	3900	138	235	3/4"
EK 6100	1127210289	6100	216	365	1"
EK 12800	1127210291	12800	453	770	1-1/2"
EK 16300	1120012418	16300	753	980	1-1/2"
EK 33300	1127210294	33300	1189	2000	2"



\* solo per Airblok / Only for Airblok

# Filtri aria industriali / Industrial air filters

## Trattamento dell'aria / Air treatment

### FQ 1000 ÷ 40000 (3 µm)

Type	Cod. filtro / Filter Code	↔			⊗
		l/min	CFM	m <sup>3</sup> /h	BSP
FQ 1000*	1127210250	1000	35.34	60	3/8"
FQ 1300*	1127210093	1300	45.94	78	1/2"
FQ 2000*	1127210096	2000	70.67	120	3/4"
FQ 3300*	1127210098	3300	116.61	198	1"
FQ 5600*	1127210254	5600	197.88	335	1"
FQ 8500*	1127210255	8500	300.35	510	1-1/2"
FQ 13000*	1127210256	13000	459.36	780	1-1/2"
FQ 16500 □	1127210257	16500	583.04	990	2"
FQ 25000 □	1127210258	25000	883.39	1500	2"
FQ 40000 □	1127210521	40000	1412.58	2760	3"

\* Completi di scaricatore manuale SC5 e manometro differenziale MDM60 / Equipped with manual drain SC5 and differential pressure gauge MDM60

□ Completi di scaricatore automatico SC20 e manometro differenziale MDM60 / Equipped with automatic drain SC20 and differential pressure gauge MDM60



### FP 1000 ÷ 40000 (1 µm - 0,1 mg/m<sup>3</sup>)

Type	Cod. filtro / Filter Code	↔			⊗
		l/min	CFM	m <sup>3</sup> /h	BSP
FP 1000*	1127210259	1000	35.34	60	3/8"
FP 1300*	1127210106	1300	45.94	78	1/2"
FP 2000*	1127210108	2000	70.67	120	3/4"
FP 3300*	1127210110	3300	116.61	198	1"
FP 5600*	1127210263	5600	197.88	335	1"
FP 8500*	1127210264	8500	300.35	510	1-1/2"
FP 13000*	1127210265	13000	459.36	780	1-1/2"
FP 16500 □	1127210266	16500	583.04	990	2"
FP 25000 □	1127210267	25000	883.39	1500	2"
FP 40000 □	1120012561	40000	1412.58	2760	3"

\* Completi di scaricatore manuale SC5 e manometro differenziale MDM60 / Equipped with manual drain SC5 and differential pressure gauge MDM60

□ Completi di scaricatore automatico SC20 e manometro differenziale MDM60 / Equipped with automatic drain SC20 and differential pressure gauge MDM60



### FD 1000 ÷ 40000 (0,01 µm - 0,01 mg/m<sup>3</sup>)

Type	Cod. filtro / Filter Code	↔			⊗
		l/min	CFM	m <sup>3</sup> /h	BSP
FD 1000*	1127210268	1000	35.34	60	3/8"
FD 1300*	1127210124	1300	45.94	78	1/2"
FD 2000*	1127210127	2000	70.67	120	3/4"
FD 3300*	1127210129	3300	116.61	198	1"
FD 5600*	1127210272	5600	197.88	335	1"
FD 8500*	1127210273	8500	300.35	510	1-1/2"
FD 13000*	1127210274	13000	459.36	780	1-1/2"
FD 16500 □	1127210275	16500	583.04	990	2"
FD 25000 □	1127210276	25000	883.39	1500	2"
FD 40000 □	1120012562	40000	1412.58	2760	3"

\* Completi di scaricatore manuale SC5 e manometro differenziale MDM60 / Equipped with manual drain SC5 and differential pressure gauge MDM60

□ Completi di scaricatore automatico SC20 e manometro differenziale MDM60 / Equipped with automatic drain SC20 and differential pressure gauge MDM60





## FC 1000 ÷ 40000 (0,003 µm)

Type	Cod. filtro / Filter Code	↔		⊘	
		l/min	CFM	m³/h	BSP
FC 1000*	1127210277	1000	35.34	60	3/8"
FC 1300*	1127210139	1300	45.94	78	1/2"
FC 2000*	1127210142	2000	70.67	120	3/4"
FC 3300*	1127210146	3300	116.61	198	1"
FC 5600*	1127210281	5600	197.88	335	1"
FC 8500*	1127210282	8500	300.35	510	1-1/2"
FC 13000*	1127210283	13000	459.36	780	1-1/2"
FC 16500 □	1127210284	16500	583.04	990	2"
FC 25000 □	1127210285	25000	883.39	1500	2"
FC 40000 □	1120012563	40000	1412.58	2760	3"



- \* Completi di scaricatore manuale SC5 e manometro differenziale MDM60 / Equipped with manual drain SC5 and differential pressure gauge MDM60
- Completi di scaricatore automatico SC20 e manometro differenziale MDM60 / Equipped with automatic drain SC20 and differential pressure gauge MDM60

## Per garage **FQ+FP+FD** / Garage pack **FQ+FP+FD**

Type	Cod. filtro / Filter Code	↔		⊘	
		l/min	CFM	m³/h	BSP
3F 1300*	1127210703	1300	45.94	78	1/2"
3F 2000*	1127210704	2000	70.67	120	3/4"
3F 5600*	1127210705	5600	197.88	335	1"



## Per carrozzerie **FQ+FP+FD+FC** / Painting pack **FQ+FP+FD+FC**

Type	Cod. filtro / Filter Code	↔		⊘	
		l/min	CFM	m³/h	BSP
4F 1300*	1127210706	1300	45.94	78	1/2"
4F 2000*	1127210707	2000	70.67	120	3/4"
4F 5600*	1127210708	5600	197.88	335	1"



## TO850 ÷ TO1850 \*

3 Stadi ad alta efficienza in un unico elemento  
High efficiency industrial filter 3 stages

Type	Code	↔		⊘	
		l/min	CFM	m³/h	BSP
TO850	1127210528	850	30	50	3/8"
TO1300	1127210529	1350	45.94	80	3/4"
TO1850	1127210530	1850	65,5	110	3/4"

\* solo per Airblok / Only for Airblok



# Filtri sterilizzatori / Sterilisation filters

## Trattamento dell'aria / Air treatment

### FST 1000 ÷ 12000 \*

Type	Cod. filtro / Filter Code	↔		⊘	
		l/min	CFM	m <sup>3</sup> /h	BSP
FST 1000	1127210510	1000	35.5	60	
FST 1500	1120012550	1500	53	90	
FST 2000	1120012551	2000	71	120	
FST 3000	1120012553	3000	106	180	
FST 4500	1120012554	4500	159	270	
FST 6000	1127210515	6000	212	360	
FST 8000	1120012557	8000	282.5	480	
FST 12000	1120012559	12000	424	720	

\* solo per Airblok / Only for Airblok



# Accessori per filtri / Accessories for filter

## Trattamento dell'aria / Air treatment

### Scaricatori condensa / Drain valves

Type	Descrizione / Description	Cod.
SC 5	Scaricatore manuale condensa Manual condensate drain valve	1127560444
SC 10	Scaricatore automatico condensa Automatic condensate drain valve	1127560368
SC 20	Scaricatore automatico condensa di grande portata Large capacity automatic condensate drain valve	1127560369





Type	Descrizione / Description	Cod.	⊘
230/50-60/1			BSP
SCE *	Scaricatore di condensa elettronico Electronic condensate drain valve	1127560102	3/4"
AIRTEC 11	Scaricatore di condensa elettronico programmabile Easy-set adjustable electronic condensate drain valve	1127560108	1/8"
AIRTEC PLUS	Scaricatore di condensa elettronico programmabile Easy-set adjustable electronic condensate drain valve	1127560694	1/4"
AIRTEC P	Scaricatore di condensa elettronico programmabile a comando pneumatico Electronic programmable condensate drain valve with pneumatic piston	1127560559	1/2"
AIRTEC 33 *	Scaricatore di condensa elettronico capacitivo Electronic capacitive condensate drain valve	1127560442	1/2"



\* solo per Airblok / Only for Airblok

## Serbatoi (con accessori\*) / Air receivers (with accessories\*)

Type	Code		Uscita aria Air outlet			ø D	H		
			l	Ø					bar
		EAN CODE	l	Ø	bar	psi	mm in	mm in	kg lb
100 CE	1124080300		100	3/4"	11	160	400/15.8	1340/52.8	50/111
270 CE	1121710100		270	3/4"	11	160	540/1.3	1950/76.8	90/200
500 CE	1121710101		500	3/4"	11	160	660/26	2160/85	131/291
500 CE 15 bar	1121710103		500	3/4"	15	218	660/26	2160/85	152/337.7
720 CE	1121710102		720	3/4"	11	160	800/31.5	2070/81.5	202/449
900 CE	1121710124		900	1"	11	160	800/31.5	2115/83.3	210/466.6
2000 PED	1121710053		2000	1"	11,5	175	1150/45.3	2780/109.5	370/822
3000 PED	1121710057		3000	1"	11,5	175	1200/47.2	2960/116.5	550/1222
4000 PED	1121710051		4000	1"	11,5	175	1430/55.8	3065/119.5	730/1622
5000 PED	1121710056		5000	1"	11,5	175	1430/55.8	3565/138.5	850/1888

\* Completi di valvola di sicurezza CE, scaricatore manuale di condensa, manometro, rubinetto uscita  
Equipped with CE safety valve, manual condensate drain valve, Pressure gauge, air outlet





## Tubi in gomma / Rubber hoses

Type	Code
Tubo in gomma: lunghezza 1,5 m; attacco 3/4" BSP - 25,279 mm Rubber hoses: length 1,5 m; connection 3/4" BSP - 25,279 mm	1127230078
Tubo in gomma: lunghezza 1,5 m; attacco 1" BSP - 31,770 mm Rubber hoses: length 1,5 m; connection 1" BSP - 31,770 mm	1127230079
Tubo in gomma: lunghezza 1,5 m; attacco 1 1/4" BSP - 40,431 mm Rubber hoses: length 1,5 m; connection 1 1/4" BSP - 40,431 mm	1127230080
Tubo in gomma: lunghezza 1,5 m; attacco 1 1/2" BSP - 46,324 mm Rubber hoses: length 1,5 m; connection 1 1/2" BSP - 46,324 mm	1127230081



## EK separatori centrifughi di condensa



### EK centrifugal separators for condensate

Type	Cod. filtro Filter Code						Cod. cartuccia Cartridge code
		EAN CODE	l/min	CFM	m³/h		
EK 2000	1127210286		2000	71	120	3/8"	1127210164
EK 2600	1127210287		2600	92	155	1/2"	1127210170
EK 3900	1127210288		3900	138	235	3/4"	1120012411
EK 6100	1127210289		6100	216	365	1"	1127210173
EK 12800	1127210291		12800	453	770	1-1/2"	1120012414
EK 16300	1120012418		16300	753,00	980	1-1/2"	1120012417
EK 33300	1127210294		33300	1.189,00	2000	2"	1127210174



## Separatori acqua-olio di condensa a carboni attivi

### Active carbon water-oil condensate separators

Type	Code				LxPxH		
		EAN CODE	l/min	CFM			m³/h
WATERSEP 1700	1127210293		1700	60	102	230x230x545 5.8x5.8x21.4	5 11.1
WATERSEP 5000	1127210295		5000	177	300	315x275x695 12.4x10.8x27.4	10 22.2
WATERSEP 12500	1127210296		12500	441	750	410x410x1025 16.5x16.5x40.4	25 55.5
KIT WATERSEP 1700	1127210700		-	-	-	-	-
KIT WATERSEP 5000	1127210701		-	-	-	-	-
KIT WATERSEP 12500	1127210702		-	-	-	-	-
KIT TEST 5 PPM	1120012573		-	-	-	-	-



# Centraline elettriche di controllo

## *Electrical control boxes*

### Supervisor



- Sistema elettronico di gestione e controllo per impianti fino a 4 compressori installati, con o senza inverter.
  - Impostazione pressione massima/minima di rete, pressione di stand-by e di sicurezza.
  - Connettività compressori: CAN bus 2 o comando a relè.
  - Funzione di selezione dei compressori per: priorità di utilizzo, rotazione priorità, equalizzazione ore lavorate.
  - Funzione datario per selezione intervalli start/stop giornalieri, settimanali, annuali.
  - Controllo temperatura ambiente d'installazione.
  - Comando a distanza e riavvio automatico.
  - Uscita allarme impianto per segnale luminoso o sonoro.
  - Monitoraggio a distanza con connessione a PC (opzionale).
- *Electronic system for control and monitoring of complex screw compressors installation (max 4 units).*
  - *Customer setting of compressed air net min/max pressure, stand-by and warning pressure.*
  - *Compressors connection by CAN-bus port or by relay control.*
  - *Main function to selection compressor active: priority start, rotation priority, equalization working hours.*
  - *Calendar setting for interval start/stop daily, monthly, year.*
  - *Continuous control of temperature of installation site.*
  - *Remote control and automatic restart.*
  - *Alarm exit for light or audio signal.*
  - *Monitoring from distance by connection to PC (option).*

### Camp Plus 4



Sistema di misura ed analisi.  
Include: sensore di pressione, pinze amperometriche e cavi di collegamento.  
A richiesta: sensore portata aria, sensore punto di rugiada, 2° sensore di pressione.

*System of measurement and analysis.  
Included: pressure sensor, clamps and cables.  
Upon request: flow meter sensor, dew point sensor, 2nd pressure sensor.*

## Air Energy Control 3 / Air Energy Eco6i



- Sistema elettronico di gestione e controllo per impianti fino a 4 compressori installati, con o senza inverter.
  - Impostazione pressione massima/minima di rete, pressione di stand-by e di sicurezza.
  - Connettività compressori: CAN bus 2 o comando a relè.
  - Funzione di selezione dei compressori per: priorità di utilizzo, rotazione priorità, equalizzazione ore lavorate.
  - Funzione datario per selezione intervalli start/stop giornalieri, settimanali, annuali.
  - Comando a distanza e riavvio automatico.
  - Monitoraggio a distanza con connessione a PC (opzionale).
- *Electronic system for control and monitoring of complex screw compressors installation (max 4 units).*
  - *Customer setting of compressed air net min/max pressure, stand-by and warning pressure.*
  - *Compressors connection by CAN-bus port or by relay control.*
  - *Main function to selection compressor active: priority start, rotation priority, equalization working hours.*
  - *Calendar setting for interval start/stop daily, monthly, year..*
  - *Remote control and automatic restart.*
  - *Monitoring from distance by connection to PC.*

# Servizio al cliente, assistenza e manutenzione

*Customer care, service and maintenance*

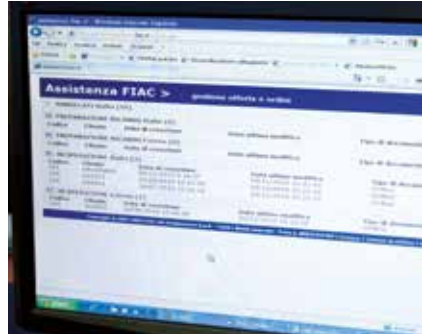

Nel progettare i nostri compressori a vite abbiamo fatto particolare attenzione alla scelta di prima qualità e affidabilità elevata, e anche alla facile accessibilità dei medesimi per facilitarne la sostituzione, durante la manutenzione ordinaria e straordinaria.

Solo grazie ad una approfondita conoscenza tecnologica dei nostri prodotti, del monitoraggio dei componenti e un aggiornamento dei nostri tecnici, con corsi nella nostra azienda di Pontecchio Marconi e insieme ai nostri partner in Italia e nel mondo possiamo offrire agli utilizzatori dei nostri impianti di aria compressa il servizio di assistenza più adeguato alle vostre esigenze e garantire il massimo dell'efficienza e la lunga durata dei nostri compressori.

La vostra garanzia di qualità si ottiene con la sostituzione solamente di parti originali FIAC, componenti che hanno superato severi test di controllo per avere il più alto livello di protezione riducendo al minimo i costi di esercizio.

*In designing our rotary screw compressors we have take particular care in choosing of first quality components and sure reliability, and more over all internal parts are easily accesible to be easier substitution during ordinary and extraordinary maintenance operation.*

*Only thanks throught knowledge of the technology, investment in monitoring equipment and update training of our technicians at FIAC headquarter in Pontecchio Marconi, with our partner in Italy and all over the world, we can offer to the FIAC screw compressors users the most appropriate service and assurance your system operating at peak efficiency for a choice that lasts over time extending the compressors lifetime your assurance off quality require only original part FIAC, that these components passed the specific severe test of quality control to obtain the highest level of protection and keeping the cost of ownership to the absolut minimum.*

# AGENTI ITALIA

## ABRUZZO - MOLISE

MAURO BISOGNINI  
Via Tiraboschi, 36/H - 60131 ANCONA  
Tel.: 071 2862055 - Fax: 071 2863155  
Cell.: 333 2250049  
e-mail: info@maurobisognini.it

## CALABRIA

ANGELO LACROCE  
Via 1a Strada, 3 - 88060 ISCA MARINA (CZ)  
Tel.+ Fax: 0967 45766  
Cell.: 333 7427984  
e-mail: angelolacroce@gmail.com

## CAMPANIA

BIENNE SAS  
Via Generale Girolamo Calà Ulloa, 10 - 80141 NAPOLI  
Tel.: 081 7807889 - 7808297 - Fax: 081 7808303  
e-mail: biennesas@vodafone.it

## EMILIA ROMAGNA

RABBI BRUNO Rappresentanze  
Via Corticella, 22 - 40128 BOLOGNA  
Tel.: 051 374191 - Fax: 051 368770  
Cell.: 335 335362 BRUNO RABBI  
Cell.: 335 5488324 Marco Malaguti  
Cell.: 347 7930834 Mirko Garavini  
e-mail: info@sircomsnc.com

## LAZIO

COMET - Agente con deposito  
Via Acerenza, 4 - 00178 ROMA  
Tel.: 06 71289181 - 06 7186059 - Fax: 06 64200072  
Cell.: Aldrovandi Luciano 348 2646078  
Cell.: Ronci Marcello 348 3312196  
e-mail: cometsas1@gmail.com

## LIGURIA

AGNELLO RAPPRESENTANZE SAS  
Via A. Siffredi, 63/9 - 16153 GENOVA  
Tel.+ Fax. 018 5363064  
Cell.: Agnello Giuseppe: 335 5388858  
Cell.: Agnello Andrea: 339 1384012  
Cell.: Agnello Patrizia: 349 4768532  
e-mail: agnellosas@agnellorappresentanze.191.it

## LOMBARDIA

FERUT RAPPRESENTANZE SRL  
Via Piave, 38 - 20833 GIUSSANO (MB)  
Tel.: 0362 355035 - Fax: 0362 355029  
e-mail: info@ferut.it

## MARCHE

L.G.R. LUCIO GIOACCHINI RAPPRESENTANZE  
Via Achille Grandi, 46/E - Zona BARACCOLA OVEST - 60131 ANCONA  
Fax: 071 2862356 - Cell.: 335 5669739  
e-mail: lucio.mgr@virgilio.it

## PIEMONTE - VALLE D'AOSTA

SERGIO CORDERO  
Via San Francesco, 43 - 10034 CHIVASSO - Fraz. BOSCHETTO (TO)  
Tel. + Fax: 011 9195244 - Cell.: 335 5461095  
e-mail: SergioCordero@libero.it

## PUGLIA - BASILICATA

GIOVANNI DE PASQUALE  
Don Guanella n°1/2 - 70125 BARI  
Tel. + Fax: 080 5424088  
Cell.: 337 832621  
e-mail: depasquale.gianni@fastwebnet.it

## SARDEGNA

SARDA RAPPRESENTANZE EDILI e INDUSTRIALI DI LUIGI MANCA & C. SAS  
Via Manin, 8 - 09045 Quartu S. Elena (CA)  
Cell.: 349 3867375  
e-mail: luigimancamail@gmail.com - Skype: luigi.manca3

## SICILIA OCCIDENTALE

GIUSEPPE CASSARÀ  
Via Mariano Campo, 15  
90123 PALERMO  
Cell.: 329 4207410  
e-mail: cassara.giuseppe54@tiscali.it

## SICILIA ORIENTALE

AESSE RAPPRESENTANZE SNC  
Via Passo Gravina, 251/C - 95125 CATANIA  
Tel.: 095 222007 - Fax: 095 221092  
e-mail: aesse-ct@tiscali.it

## TOSCANA - UMBRIA

CENNINI RAPPRESENTANZE di CENNINI GIANLUCA & C. SAS  
Via F. Morozzi, 29 - 53034 COLLE DI VAL D'ELSA (SI)  
Fax: 0577 959910  
Cell.: 348 6032608  
e-mail: cennini.gianluca@virgilio.it

## VENETO - TRENTO ALTO ADIGE FRIULI VENEZIA GIULIA

MAFAR di GHINELLI M.& DEGLI AGOSTINI F. & C. SAS  
Via Caselline, 281 - 41058 VIGNOLA (MO)  
Tel.: 059 773747 - Fax: 059 763652  
Cell.: Carlo Ghinelli: 335 5435612  
Cell.: Massimo Ghinelli: 335 6151622  
Cell.: Fabrizio Degli Agostini: 335 6286214  
Cell.: Marco Degli Agostini: 334 6786555  
e-mail: mafar@mafar.info

Sistema di gestione della qualità certificato UNI EN ISO 9001:2015. / *Quality system certified according to UNI EN ISO 9001:2015.*



**ANIMA**<sup>®</sup>



Associazione Costruttori Pompe e Compressori  
*Italian Association of Pump and Compressor Manufacturers*

FIAC SpA, nell'ottica di migliorare costantemente i prodotti, si riserva di aggiornare le caratteristiche presenti in questo catalogo senza preavviso. I requisiti dei prodotti sono indicati chiaramente. Le immagini sono puramente indicative.

*To guarantee the continued improvement of our range of products, FIAC reserves the right to up-date the technical characteristics shown in this catalogue without prior warning. Specifications of products are clearly indicated. Photographs are for illustrative purposes only.*



**FIAC Air Compressors S.p.A.**

Headquarter

Via Vizzano, 23 - 40037 Pontecchio Marconi - (Bologna) Italy

Tel.: +39 051 678 68 11

fiac@fiac.it - **www.fiac.it**



[www.fiac.it](http://www.fiac.it)



on  
App Store  
Play store

